

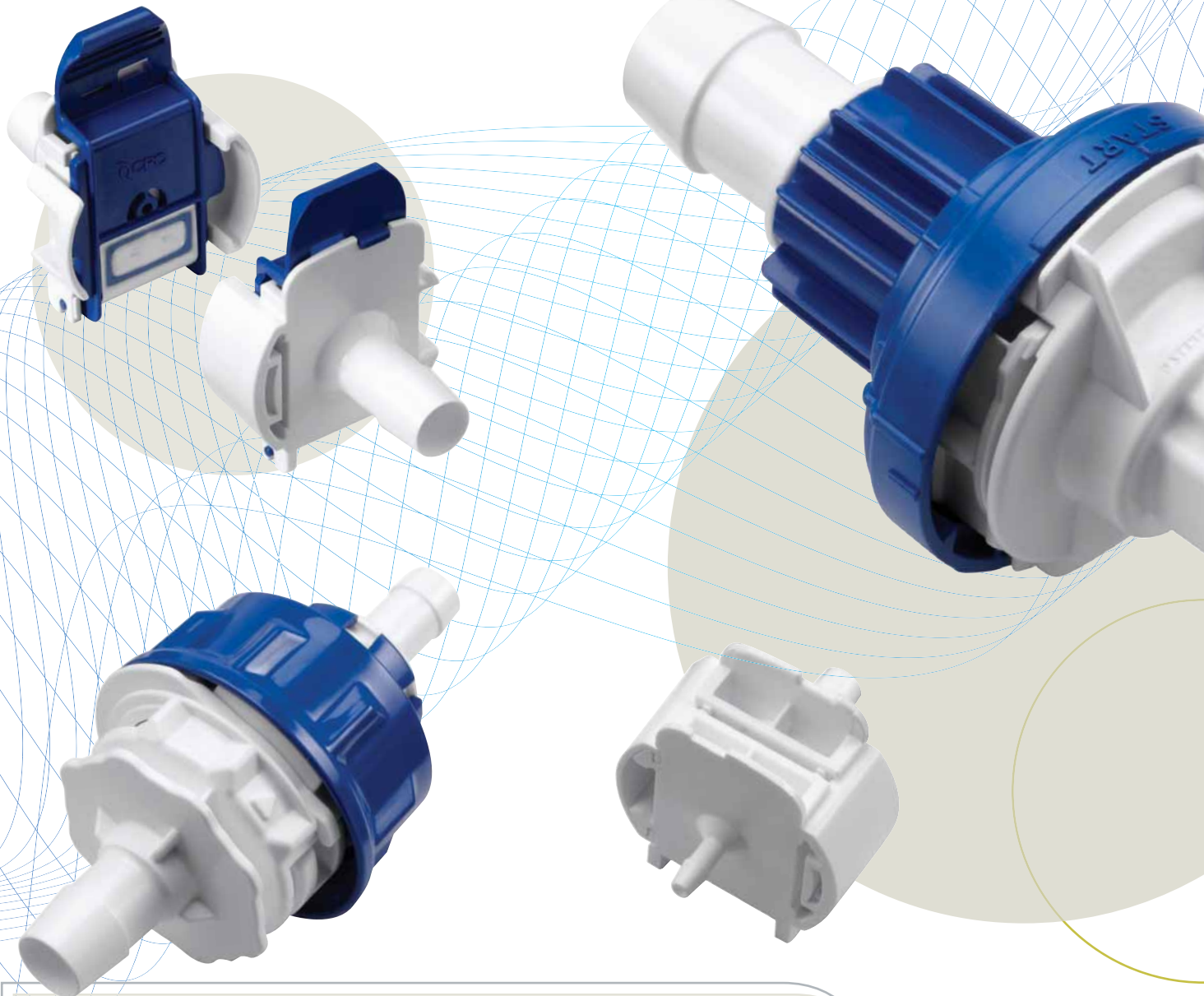

# CPC™

A DOVER® COMPANY



**CONNECTION SOLUTIONS for  
BIOPHARMACEUTICAL  
PROCESSES**



## **Smart fluid handling to take you forward, faster** ● ● ●

CPC (Colder Products Company) is the leader in the design and manufacture of single-use connection technology and connectors for the life sciences markets. CPC offers a wide variety of bioprocessing solutions including sterile connect, sterile disconnect, SIP connections and quick connects. Our innovative designs provide flexibility for biopharmaceutical manufacturers to easily combine multiple components, single-use or hybrid systems including process containers, tubing manifolds, transfer lines, bioreactors and other bioprocess equipment.

Robust and easy-to-use single-use connectors from CPC maintain flow path sterility and integrity while enabling biopharmaceutical manufacturers to improve production yields, decrease time-to-market and reduce costs. Our genderless sterile connectors simplify process integration, maximize flexibility and streamline supply chain efficiencies.

CPC makes people's lives better by developing innovative high quality products that make fluid handling safe and easy.

### **HOW TO CONTACT**

Contact CPC's Customer Service at 1-800-444-2474 or 651-645-0091. You can also visit [cpcworldwide.com/bio](http://cpcworldwide.com/bio) or send an email to [info@cpcworldwide.com](mailto:info@cpcworldwide.com).

### **QUALITY**

CPC meets or exceeds our customers' expectations. Everyone is involved, from our suppliers to our distribution network, and most important, our employees. CPC measures and continually improves our standards of product quality, support services and overall customer and employee satisfaction. CPC's Quality System conforms to ISO 9001:2008 and ISO 13485 standards. Products for bioprocessing applications are manufactured in our ISO Class 7 certified cleanroom.

### **NEW PRODUCTS**

Exciting additions to CPC's product offering include:

- MPC/MPX Back-to-Back Insert Adapters Page 9
- AseptiQuik® S Connectors Page 20
- Genderless AseptiQuik® G Connectors Page 22
- AseptiQuik® X Connectors Page 28
- AseptiQuik® G STC Connectors Page 32

# INTRODUCTION

## Understanding Single-Use

### WHAT IS SINGLE-USE

Plastic-based processing equipment consisting of key components including bags, tubing, filters and connection technologies used in the development and production of biopharmaceutical drugs.

### WHY SINGLE-USE

Increasing global demand for new biologics, vaccines and cell therapies is driving manufacturers to replace traditional stainless equipment with single-use systems. The need to produce multiple drugs within a single facility and the evolving demand for biosimilars (biogenerics) are drivers for implementing single-use or hybrid systems (that combine both stainless- and plastic-based process technologies).

### BENEFITS OF SINGLE-USE

#### OPERATIONAL EFFICIENCIES

Increases flexibility and faster batch turnaround.

#### COST EFFECTIVENESS

Minimizes cleaning and validation requirements.

#### ECONOMIC ADVANTAGES

Reduces capital expenditures and facility footprints.

#### SAFETY AND QUALITY

Improves sterility assurance while decreasing the risk of cross-contamination and product loss.

#### FLEXIBILITY

Facilitates multi-drug production and fast product changeover.

#### SUSTAINABILITY

Consumes less water, energy and chemicals when compared to stainless-based processing. Single-use plastic waste is an excellent fuel source for waste-to-energy conversion.



### CPC'S ROLE IN SINGLE-USE

Drug manufacturers receive a wide range of single-use subsystems including bags, tubing manifolds and filter assemblies to create their desired production process. CPC offers the widest range of single-use connection solutions to reliably bring these technologies together while maintaining the sterility and integrity of the overall system. Our connectors are used throughout upstream and downstream unit operations, and have become an industry standard over the past 20 years.



## WHAT IS A CLOSED SYSTEM

A process or processing equipment that maintains a sterile barrier between the media/drug product and the external environment. A closed system reduces risks and increases safety by maintaining flow path sterility and media integrity.

## HOW DOES CPC ENABLE CLOSED SYSTEMS

CPC's broad line of sterile connect and disconnect technologies allow closed pre-sterilized single-use assemblies to be brought together to form a complete system. AseptiQuik offers closed connection options from 1/8-to 1-inch tubing. CPC's award winning Steam-Thru technology creates a sterile connection between stainless equipment and single-use to effectively close hybrid systems.

## VISIT US ONLINE FOR INTERACTIVE WEB TOOLS

[cpcworldwide.com/bio](http://cpcworldwide.com/bio)



## ALSO ON THE WEB

- Validation Test Reports
- Watch Product Videos
- Application Articles
- Chemical Compatibility
- CAD Models
- Regulatory & Compliance Documents
- Ask Our Engineers

# TABLE OF CONTENTS

## LEGEND

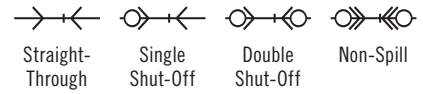

Note: Product images may not be to scale

PAGE | DESCRIPTION



- 6 MPC:** Easy-to-use and secure connection for critical fluid applications; includes pressure sealing caps and plugs with optional locking sleeves.  
**Material:** Medical-grade ABS, medical-grade polycarbonate and polysulfone (USP Class VI, ADCF)  
**Tubing ID Sizes:** 1/8" to 3/8" (3.2mm to 9.5mm)



- 9 BACK-TO-BACK ADAPTERS:** Allow end users to connect single-use systems that may feature identical connections at the end of their tubing.  
**Material:** Medical-grade polycarbonate and polysulfone, USP Class VI, ADCF



- 10 MPX:** Larger flow, easy-to-use and secure connection for critical fluid applications; includes pressure sealing caps and plugs with optional locking sleeves.  
**Material:** Medical-grade polycarbonate and polysulfone, USP Class VI, ADCF  
**Tubing ID Sizes:** 3/8" to 1/2" (9.5mm to 12.7mm)



- 12 SANITARY SERIES:** Attaches directly to 3/4", 1" and 1-1/2" sanitary terminations to provide greater flexibility for integrating components into single-use or hybrid process systems.  
**Material:** Medical-grade polysulfone, USP Class VI, ADCF  
**Termination Sizes:** 3/4", 1" and 1-1/2" sanitary



- 14 SANIQUIK™:** Integral sanitary termination attaches to hard-plumbed systems with tri-clover clamps; permits quick and easy connection to single-use bag systems, manifolds or tube sets.  
**Material:** 316L stainless steel  
**Termination Sizes:** 3/4" and 1-1/2" sanitary



- 16 MPU:** Larger flow twist-to-connect design features easy-to-use locking mechanism that guards against accidental disconnects.  
**Material:** Medical-grade polysulfone, USP Class VI, ADCF  
**Tubing ID Sizes:** 3/4" (19.0mm)



- 18 HFC39:** Features sterile disconnect functionality with automatic shut-off valve, preventing external organisms from entering the media flow path upon disconnection.  
**Material:** Medical-grade polysulfone, USP Class VI, ADCF  
**Termination Sizes:** 1/4", 3/8" and 1/2" HB (6.4mm, 9.5mm, 12.7mm)





**20 ASEPTIQUIK® S:** Genderless design provides quick and easy sterile connections for small-flow applications.

**Material:** Medical-grade polycarbonate, USP Class VI, ADCF

**Termination Sizes:** 1/8", 1/4" and 3/8" HB (3.2mm, 6.4mm and 9.5mm), 3/4" sanitary and MPC insert



**22 ASEPTIQUIK® G:** Robust genderless connectors provide quick and easy sterile connections and simplify systems integration.

**Material:** Medical-grade polycarbonate, USP Class VI, ADCF

**Termination Sizes:** 1/4", 3/8", 1/2", 3/4" ID hose barb (6.4mm, 9.5mm, 12.7mm, 19.0mm) and 3/4" sanitary



**24 ASEPTIQUIK® C:** Provides a quick and easy sterile connection, even in non-sterile environments.

**Material:** Medical-grade polycarbonate, USP Class VI, ADCF

**Termination Sizes:** 3/8" and 1/2" HB (9.5mm and 12.7mm) and 3/4" sanitary



**26 ASEPTIQUIK® DC:** All-in-one, single-use connection technology offering both a sterile connect and a sterile disconnect.

**Material:** Medical-grade polycarbonate, USP Class VI, ADCF

**Termination Sizes:** 1/4", 3/8" and 1/2" HB (6.4mm, 9.5mm, 12.7mm)



**28 ASEPTIQUIK® X:** Robust large format design enables quick sterile transfer for high flow single-use applications.

**Material:** Medical-grade polycarbonate, USP Class VI, ADCF

**Termination Sizes:** 3/4" and 1" ID hose barb (19.0mm and 25.4mm) and 1-1/2" sanitary



**30 STEAM-THRU® CONNECTIONS:** Allow quick and easy sterile connection via SIP between biopharmaceutical processing equipment and disposable bag and tube assemblies.

**Material:** Medical-grade polysulfone, USP Class VI, ADCF

**Termination Sizes:** 3/8" and 1/2" HB (9.5mm and 12.7mm) and 3/4" sanitary



**32 ASEPTIQUIK® STC:** Allows a gendered or genderless AseptiQuik sterile connection to be steamed on to stainless equipment via SIP.

**Material:** Medical-grade polycarbonate and polysulfone, USP Class VI, ADCF



# MPC SERIES CONNECTOR

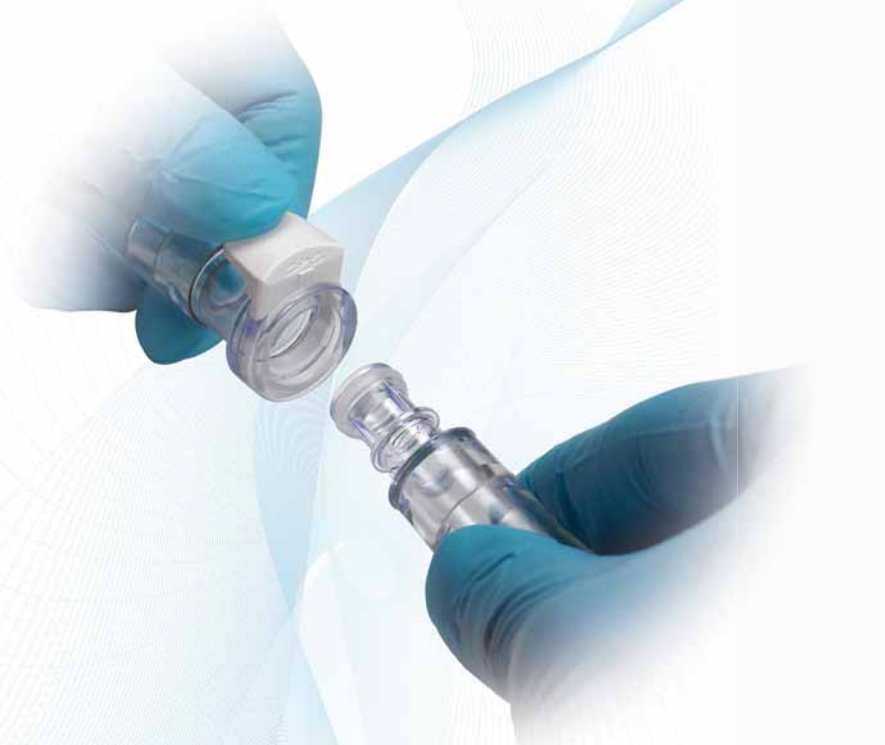

**MPC Series couplings** add ease of use and security to critical fluid handling applications. Choose from a full line of connectors and configurations, including pressure sealing caps and plugs, in sizes to fit 1/8" to 3/8" tubing. MPC couplings offer optional locking sleeves to further guard against accidental disconnects. In addition, coupling halves can be rotated when connected to reduce tube kinks.

## FEATURES

Ergonomic thumb latch

USP Class VI materials

Sterilizable by autoclave, EtO, e-beam, or gamma

Parting line-free hose barb

ADCF-free materials

## BENEFITS

Easy to operate – even with gloved hands

Meet biocompatibility requirements

Reusable, yet economical enough to allow disposability

Eliminates potential leak path

Meet BSE/TSE requirements

## Specifications ● ● ●

### PRESSURE:

Vacuum to 60 psi, 4.1 bar

### TEMPERATURE:

#### Polycarbonate:

-40°F to 250°F (-40°C to 121°C)

#### Polysulfone:

-40°F to 300°F (-40°C to 149°C)

### MATERIALS:

#### Main components:

Polycarbonate (purple tint), USP Class VI, ADCF  
Polysulfone (amber tint), USP Class VI, ADCF

#### Locking sleeves:

Polysulfone (white), USP Class VI, ADCF

#### Thumb Latches:

Polycarbonate (white), USP Class VI, ADCF  
Polysulfone (amber tint), USP Class VI, ADCF

**O-rings:** Silicone (clear), platinum-cured, USP Class VI, ADCF

### STERILIZATION:

**Gamma:** Up to 50 kGy irradiation

#### Autoclave:

**Polycarbonate:** Up to 250°F (121°C), 30 minutes, up to 10 repetitions. Sterilize uncoupled only.

**Polysulfone:** Up to 270°F (132°C) for 60 minutes, up to 25 repetitions. Sterilize uncoupled only.

### TUBING SIZES:

1/8" to 3/8" ID (3.2mm to 9.5mm)

**WARNING:** Pressure, temperature, chemicals, and operating environment can affect the performance of couplings. It is the customer's responsibility to test the suitability of CPC's products in their own application conditions.

⚠ This graph is intended to give you a general idea of the performance capabilities of each product line. The shaded area of the graph represents the operating range of the product family, i.e. upper and lower values are shown. Therefore, depending on the exact coupling configurations selected, you can reasonably expect values to fall within the shaded area.

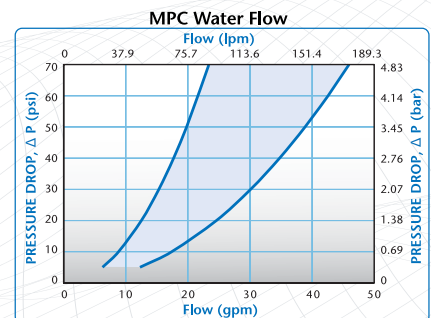

# MPC SERIES CONNECTOR DIMENSIONS

**A** = Height/Diameter

**B** = Total Length

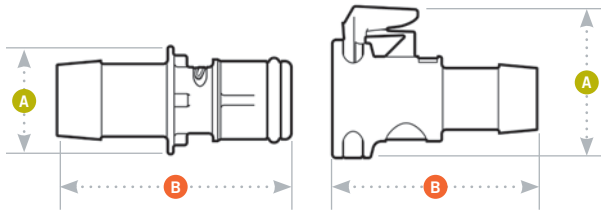

**A** = Height/Diameter

**B** = Total Length

## Coupling Bodies

### • POLYCARBONATE



**TERMINATION  
IN-LINE  
HOSE BARB**

TUBING	METRIC EQ.	FLOW	STRAIGHT THRU	A	B
1/8" ID	3.2mm ID	.09"	MPC17002T03	.96 (24.4)	1.10 (27.9)
1/4" ID	6.4mm ID	.21"	MPC17004T03	.96 (24.4)	1.10 (27.9)
3/8" ID	9.5mm ID	.29"	MPC17006T03	.96 (24.4)	1.10 (27.9)



**IN-LINE HOSE BARB  
WITH LOCK**

1/8" ID	3.2mm ID	.09"	MPCK17002T03	.99 (25.2)	1.10 (27.9)
1/4" ID	6.4mm ID	.21"	MPCK17004T03	.99 (25.2)	1.30 (33.0)
3/8" ID	9.5mm ID	.29"	MPCK17006T03	.99 (25.2)	1.30 (33.0)

### • POLYSULFONE



**TERMINATION  
IN-LINE  
HOSE BARB**

TUBING	METRIC EQ.	FLOW	STRAIGHT THRU	A	B
1/8" ID	3.2mm ID	.09"	MPC17002T39	.96 (24.4)	1.10 (27.9)
1/4" ID	6.4mm ID	.21"	MPC17004T39	.96 (24.4)	1.10 (27.9)
3/8" ID	9.5mm ID	.29"	MPC17006T39	.96 (24.4)	1.10 (27.9)



**IN-LINE HOSE BARB  
WITH LOCK**

1/8" ID	3.2mm ID	.09"	MPCK17002T39	.99 (25.2)	1.10 (27.9)
1/4" ID	6.4mm ID	.21"	MPCK17004T39	.99 (25.2)	1.30 (33.0)
3/8" ID	9.5mm ID	.29"	MPCK17006T39	.99 (25.2)	1.30 (33.0)

## Coupling Inserts

### • POLYCARBONATE



**TERMINATION  
IN-LINE  
HOSE BARB**

TUBING	METRIC EQ.	FLOW	STRAIGHT THRU	O-RING	A	B
1/8" ID	3.2mm ID	.09"	MPC22002T03M	Silicone Seal USP Class VI	.60 (15.2)	1.10 (27.9)
1/4" ID (33.0)	6.4mm ID	.21"	MPC22004T03M	Silicone Seal USP Class VI	.60 (15.2)	1.30

### • POLYSULFONE



**TERMINATION  
IN-LINE  
HOSE BARB**

TUBING	METRIC EQ.	FLOW	STRAIGHT THRU	O-RING	A	B
1/8" ID	3.2mm ID	.09"	MPC22002T39M	Silicone Seal USP Class VI	.60 (15.2)	1.10 (27.9)
1/4" ID	6.4mm ID	.21"	MPC22004T39M	Silicone Seal USP Class VI	.60 (15.2)	1.30 (33.0)
3/8" ID	9.5mm ID	.29"	MPC22006T39M	Silicone Seal USP Class VI	.60 (15.2)	1.30 (33.0)



# MPC SERIES CONNECTOR (cont.)

## Mating Parts



**SEALING CAP**  
MPC32003  
MPC32039

**SEALING CAP W/LOCK**  
MPCK32003  
MPCK32039

**MATERIAL**  
Polycarbonate  
Polysulfone

**A**  
.96 (24.4)  
.99 (25.2)

**B**  
1.30 (33.0)  
1.30 (33.0)

**SEALING PLUG**  
MPC30003M  
MPC30039M

**O-RING**  
Silicone Seal USP Class VI  
Silicone Seal USP Class VI

**MATERIAL**  
Polycarbonate  
Polysulfone

**A**  
.75 (19.1)  
.75 (19.1)

**B**  
1.24 (31.5)  
1.24 (31.5)

**PART NO.**  
MPC30L  
MPC32L

**DESCRIPTION**  
Leash plug for MPC body  
Leash cap for MPC insert

**MATERIALS**  
Soft, flexible, medical-grade PVC  
Soft, flexible, medical-grade PVC

*Note: MPC Series mates with Back-to-Back Adapters (page 9), Sanitary Series and SaniQuik™ (pages 12-15).*



# BACK-TO-BACK SERIES CONNECTOR



**MPC/MPX Back-to-Back Adapters** give end users the flexibility of connecting single-use systems that feature identical coupling connections at the end of their tubing. Combining both MPC and MPX couplings provides a reducing option for users who need to transition between tubing diameters ranging from 1/8" to 1/2".

## FEATURES

Compatible with MPC and MPX Series inserts

Tubing reduction option

Ergonomic thumb latches

ADCF-free materials

## BENEFITS

Easy conversion to industry standard connections or single-use systems

Allows easy transition between multiple size tubing from 1/8" to 1/2" ID

Easy to operate - even with gloved hands

Meet BSE/TSE requirements

## Specifications

### PRESSURE:

Vacuum to 60 psi, 4.1 bar

### TEMPERATURE:

**Polycarbonate:**  
-40°F to 250°F (-40°C to 121°C)

**Polysulfone:**  
-40°F to 300°F (-40°C to 149°C)

### MATERIALS:

#### Main Components:

Polycarbonate (purple tint), USP Class VI, ADCF  
Polysulfone (amber tint), USP Class VI, ADCF

#### Thumb Latches:

Polycarbonate (white), USP Class VI, ADCF  
Polysulfone (amber tint), USP Class VI, ADCF

#### O-rings:

Silicone (clear), platinum-cured, USP Class VI, ADCF

### STERILIZATION:

**Gamma:** Up to 50 kGy irradiation

#### Autoclave:

**Polycarbonate:** Up to 250°F (121°C) for 30 minutes, up to 10 repetitions.  
Sterilize uncoupled only.

**Polysulfone:** Up to 270°F (132°C) for 60 minutes, up to 25 repetitions.  
Sterilize uncoupled only.

**WARNING:** Pressure, temperature, chemicals, and operating environment can affect the performance of couplings. It is the customer's responsibility to test the suitability of CPC's products in their own application conditions.

## Back-To-Back Insert Adapters

### • POLYSULFONE



PART NO.	TYPE	A	B
MPC22C2239M	MPC to MPC	0.74 (18.8)	2.04 (51.0)
MPC22X2239M	MPC to MPX	0.98 (25.0)	2.42 (61.5)
MPX22X2239M	MPX to MPX	0.98 (25.0)	2.73 (69.5)

**Note:**  
Mates with MPC and MPX bodies, inserts and sealing caps and plugs (pages 6-11).

## Back-To-Back Body Adapters

### • POLYCARBONATE



PART NO.	TYPE	A	B
MPC17C1703	MPC to MPC	.96 (24.5)	1.81 (46.0)
MPX17X1703	MPX to MPX	1.28 (32.5)	2.44 (62.0)
MPC17X1703	MPC to MPX	1.28 (32.5)	2.13 (54.1)

### • POLYSULFONE



PART NO.	TYPE	A	B
MPC17C1739	MPC to MPC	.96 (24.5)	1.81 (46.0)
MPX17X1739	MPX to MPX	1.28 (32.5)	2.44 (62.0)
MPC17X1739	MPC to MPX	1.28 (32.5)	2.13 (54.1)

All measurements are in inches (millimeters) unless otherwise noted. Tubing must meet stated inside and outside diameters.

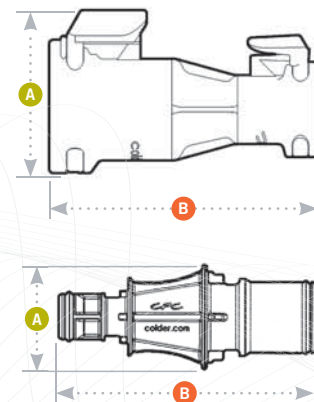

A = Height/Diameter

B = Total Length

# MPX SERIES CONNECTOR

## Specifications ● ● ●

### PRESSURE:

Vacuum to 60 psi, 4.1 bar

### TEMPERATURE:

#### Polycarbonate:

-40°F to 250°F (-40°C to 121°C)

#### Polysulfone:

-40°F to 300°F (-40°C to 149°C)

### MATERIALS:

#### Main components:

Polycarbonate (purple tint), USP Class VI, ADCF  
Polysulfone (amber tint), USP Class VI, ADCF

#### Locking sleeves:

Polysulfone (white), USP Class VI, ADCF

#### Thumb Latches:

Polycarbonate (white), USP Class VI, ADCF  
Polysulfone (amber tint), USP Class VI, ADCF

**O-rings:** Silicone (clear), platinum-cured, USP Class VI, ADCF

### STERILIZATION:

**Gamma:** Up to 50 kGy irradiation

#### Autoclave:

**Polycarbonate:** Up to 250°F (121°C), 30 minutes, up to 10 repetitions. Sterilize uncoupled only.

**Polysulfone:** Up to 270°F (132°C) for 60 minutes, up to 25 repetitions. Sterilize uncoupled only.

**TUBING SIZES:** 3/8" to 1/2" ID (9.5mm to 12.7mm)

**WARNING:** Pressure, temperature, chemicals, and operating environment can affect the performance of couplings. It is the customer's responsibility to test the suitability of CPC's products in their own application conditions.



**MPX Series couplings** add ease of use and security to your most critical fluid handling applications. Choose from a full line of connectors and configurations, including pressure sealing caps and plugs in sizes to fit 3/8" and 1/2" tubing. MPX couplings offer optional locking sleeves to further guard against accidental disconnects. In addition, coupling halves can be rotated when connected reducing tube kinks.

## FEATURES

Ergonomic thumb latch

USP Class VI materials

Sterilizable by autoclave, EtO, e-beam, or gamma

Parting line-free hose barb

ADCF-free materials

## BENEFITS

Easy to operate – even with gloved hands

Meet biocompatibility requirements

Reusable, yet economical enough to allow disposability

Eliminates potential leak path

Meet BSE/TSE requirements

⚠ This graph is intended to give you a general idea of the performance capabilities of each product line. The shaded area of the graph represents the operating range of the product family, i.e. upper and lower values are shown. Therefore, depending on the exact coupling configurations selected, you can reasonably expect values to fall within the shaded area.

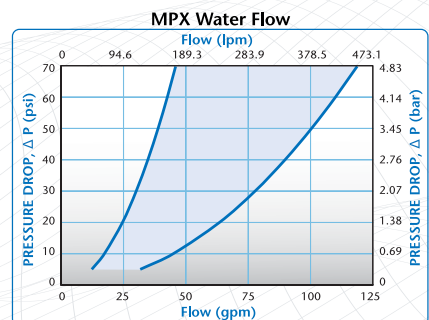

# MPX SERIES CONNECTOR DIMENSIONS

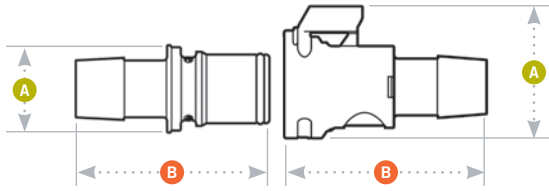

**A** = Height/Diameter  
**B** = Total Length

## Coupling Bodies

### • POLYCARBONATE

TERMINATION	TUBING	METRIC EQ.	FLOW	STRAIGHT THRU	A	B
IN-LINE HOSE BARB	1/2" ID	12.7mm ID	.50"	MPX17803	1.28 (32.5)	1.96 (49.8)
IN-LINE HOSE BARB WITH LOCK	1/2" ID	12.7mm ID	.50"	MPXK17803	1.28 (32.5)	1.96 (49.8)

### • POLYSULFONE

TERMINATION	TUBING	METRIC EQ.	FLOW	STRAIGHT THRU	A	B
IN-LINE HOSE BARB	1/2" ID	12.7mm ID	.50"	MPX17839	1.28 (32.5)	1.96 (49.8)
IN-LINE HOSE BARB WITH LOCK	1/2" ID	12.7mm ID	.50"	MPXK17839	1.28 (32.5)	1.96 (49.8)

## Coupling Inserts

### • POLYCARBONATE

TERMINATION	TUBING	METRIC EQ.	FLOW	STRAIGHT THRU	O-RING	A	B
IN-LINE HOSE BARB	3/8" ID	9.5mm ID	.38"	MPX22603M	Silicone Seal USP Class VI	.85 (21.6)	1.90 (48.3)
	1/2" ID	12.7mm ID	.50"	MPX22803M	Silicone Seal USP Class VI	.85 (21.6)	1.90 (48.3)

### • POLYSULFONE

TERMINATION	TUBING	METRIC EQ.	FLOW	STRAIGHT THRU	O-RING	A	B
IN-LINE HOSE BARB	3/8" ID	9.5mm ID	.38"	MPX22639M	Silicone Seal USP Class VI	.85 (21.6)	1.90 (48.3)
	1/2" ID	12.7mm ID	.50"	MPX22839M	Silicone Seal USP Class VI	.85 (21.6)	1.90 (48.3)

## Mating Parts

SEALING CAP	SEALING CAP W/LOCK	MATERIAL	A	B
MPX32003	MPXK32003	Polycarbonate	1.28 (32.5)	1.67 (42.4)
MPX32039	MPXK32039	Polysulfone	1.28 (32.5)	1.67 (42.4)

SEALING PLUG	O-RING	MATERIAL	A	B
MPX30003M	Silicone Seal USP Class VI	Polycarbonate	1.10 (27.9)	1.66 (42.2)
MPX30039M	Silicone Seal USP Class VI	Polysulfone	1.10 (27.9)	1.66 (42.2)

Note: MPX Series mates with Back-to-Back Adapters (page 9), Sanitary Series and SaniQuik™ (pages 12-15).

All measurements are in inches (millimeters) unless otherwise noted. Tubing must meet stated inside and outside diameters.

# SANITARY SERIES CONNECTOR



## Specifications ● ● ●

### PRESSURE:

Vacuum to 60 psi, 4.1 bar

### TEMPERATURE:

-40°F to 300°F (-40°C to 149°C)

### MATERIALS:

#### Main components:

Polysulfone (amber tint), USP Class VI, ADCF

**O-rings:** Silicone (clear), platinum-cured, USP Class VI, ADCF

### STERILIZATION:

**Gamma:** Up to 50 kGy irradiation

**Autoclave:** Up to 270°F (132°C) for 60 minutes, up to 25 repetitions. Sterilize uncoupled only.

### TERMINATION SIZES:

3/4", 1" and 1-1/2" sanitary

**WARNING:** Pressure, temperature, chemicals, and operating environment can affect the performance of couplings. It is the customer's responsibility to test the suitability of CPC's products in their own application conditions.

**Sanitary couplings** attach directly to 3/4", 1" and 1-1/2" sanitary terminations to provide greater flexibility for integrating components into single-use or hybrid (single-use to stainless) process systems. Standard bag systems with quick couplings can be easily connected to equipment with sanitary terminations, while single-use cartridge filters can be converted to incorporate quick couplings for greater system modularity.

**Note:**  
Mates with MPC and MPX bodies, inserts and sealing caps and plugs and Back-to-Back Adapters (pages 6-11).

## FEATURES

3/4", 1" and 1-1/2" sanitary terminations

Compatible with MPC and MPX Series couplings

Integral coupling adaptor

ADCF-free materials

## BENEFITS

Install to equipment with sanitary gaskets and sanitary clamps

Quick and easy connections to industry standard plastic couplings on single-use bags and tube sets

Provides flexibility to easily convert sanitary terminations on filter cartridge or equipment

Meet BSE/TSE requirements

# SANITARY SERIES CONNECTOR DIMENSIONS

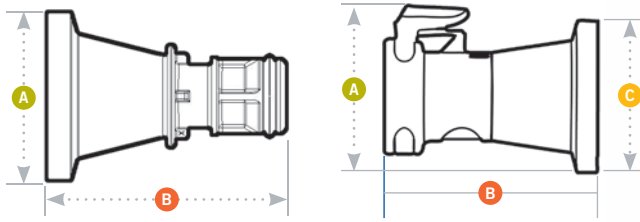

- A** = Height/Diameter
- B** = Total Length
- C** = Outside Diameter

## Coupling Bodies • POLYSULFONE



PART NO.	SIZE	A	B	C
MPC3301239	3/4"	.98 (24.9)	1.40 (35.6)	1.0 (25.4)
MPX3301239	3/4"	1.28 (32.5)	1.70 (43.2)	1.0 (25.4)
MPC3301639	1"	1.50 (38.1)	1.40 (35.6)	1.50 (38.1)

## Coupling Inserts • POLYSULFONE



PART NO.	SIZE	O-RING	A	B
MPC44012T39M	3/4"	Silicone Seal USP Class VI	.98 (24.9)	1.40 (35.6)
MPC44024T39M	1-1/2"	Silicone Seal USP Class VI	1.98 (50.3)	1.40 (35.6)
MPX44012T39M	3/4"	Silicone Seal USP Class VI	.98 (24.9)	1.71 (43.4)
MPX44024T39M	1-1/2"	Silicone Seal USP Class VI	1.98 (50.3)	1.71 (43.4)

All measurements are in inches (millimeters) unless otherwise noted. Tubing must meet stated inside and outside diameters. Note: Sanitary couplings are compatible with both stainless steel and plastic clamps. Clamps and gaskets are referenced for illustration and are not available through CPC.

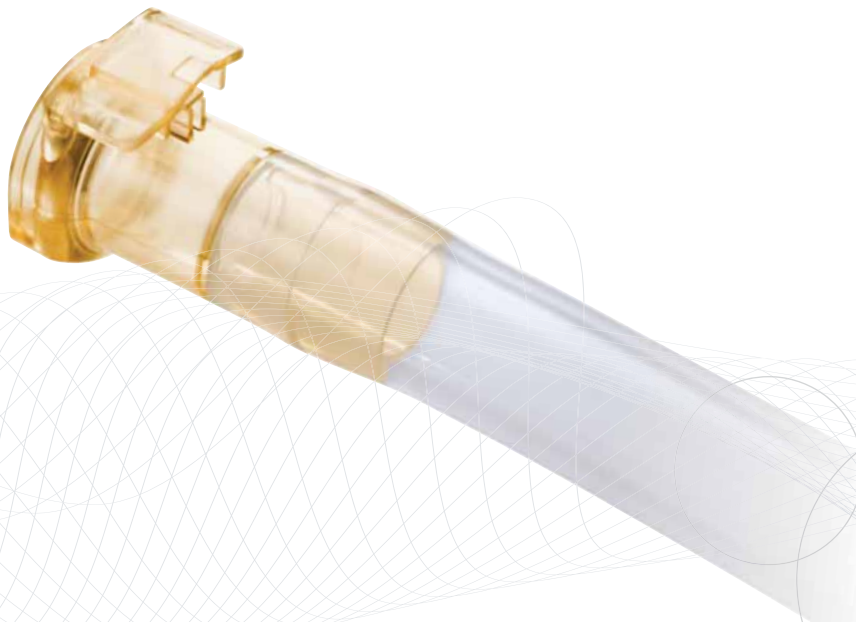

# SANIQUIK™ SERIES CONNECTOR



## Specifications ● ● ●

### PRESSURE:

Vacuum to 60 psi, 4.1 bar

### TEMPERATURE:

-40°F to 300°F (-40°C to 149°C)

### MATERIALS:

**Main component:** 316L stainless steel

**O-rings:** Silicone (clear), platinum-cured, USP Class VI, ADCF

**STERILIZATION:** Autoclave

### TERMINATION SIZES:

3/4" and 1-1/2" sanitary

**WARNING:** Pressure, temperature, chemicals, and operating environment can affect the performance of couplings. It is the customer's responsibility to test the suitability of CPC's products in their own application conditions.

**CPC's SaniQuik™ connection** answers the question of how to integrate single-use components with your existing stainless processing equipment. This integral sanitary termination attaches to hard-plumbed systems with tri-clover clamps. Once attached it permits quick and easy connection to single-use bag systems, manifolds or tube sets with CPC disposable coupling bodies. SaniQuik connections reduce sanitary gasket replacement, enabling cost-effective media transfer solutions for feeding, harvesting or sampling applications.

*Note:  
Mates with MPC and  
MPX bodies, inserts  
and sealing caps and  
plugs and Back-to-Back  
Adapters (pages 6 -11).*

## FEATURES

3/4" and 1-1/2" sanitary standard terminations

Compatible with MPC and MPX Series couplings

Integral coupling adaptor

ADCF-free materials

## BENEFITS

Connect to hard plumbed systems with sanitary gaskets and sanitary clamps

Quick and easy connections to industry standard plastic couplings on single-use bag and tube sets

Disconnecting coupling reduces sanitary gasket replacement

Meet BSE/TSE requirements

# SANIQUIK™ SERIES CONNECTOR DIMENSIONS

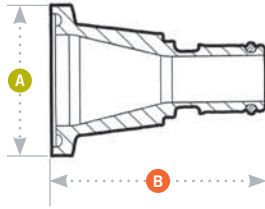

**A** = Height/Diameter  
**B** = Total Length

## Connections • 316L STAINLESS



**DESCRIPTION**  
 SILICONE SEAL  
 USP CLASS VI

**PART NO.**  
 SQCC221212M  
 SQCC222424M  
 SQCX221212M  
 SQCX222416M  
 SQCX222424M

**MATING COUPLING**  
 MPC Series  
 MPC Series  
 MPX Series  
 MPX Series  
 MPX Series

**SANITARY SIZE**  
 3/4"  
 1-1/2"  
 3/4"  
 1-1/2"  
 1-1/2"

**SANITARY BORE**  
 3/4"  
 1-1/2"  
 3/4"  
 1"  
 1-1/2"

**A**  
 .98" (24.9)  
 1.98" (50.3)  
 .98" (24.9)  
 1.98" (50.3)  
 1.98" (50.3)

**B**  
 1.39" (35.3)  
 1.50" (38.1)  
 1.43" (39.1)  
 1.50" (38.1)  
 1.50" (38.1)

## Accessories • SILICONE (CLEAR)

**DESCRIPTION**  
 PLATINUM-CURED  
 USP CLASS VI  
 REPLACEMENT  
 SEALS

**PART NO.**  
 2260100  
 2260200

**MATING SANIQUIK**  
 SQCC221212M, SQCC222424M  
 SQCX221212M, SQCX222416M, SQCX222424M

All measurements are in inches (millimeters) unless otherwise noted. Tubing must meet stated inside and outside diameters.

**NOTES:**

A large grid area for notes, consisting of a 20x20 grid of squares. The grid is intended for users to provide additional information or specifications related to the connectors.



# MPU SERIES CONNECTOR



## Specifications ● ● ●

### PRESSURE:

Vacuum to 35 psi, 2.4 bar

### TEMPERATURE:

-40°F to 300°F (-40°C to 149°C)

### MATERIALS:

#### Main components:

Polysulfone (amber tint), USP Class VI, ADCF

**O-rings:** Silicone (clear), platinum-cured, USP Class VI, ADCF

### STERILIZATION:

**Gamma:** Up to 50 kGy irradiation

**Autoclave:** Up to 270°F (132°C) for 60 minutes, up to 25 repetitions. Sterilize uncoupled only.

### TUBING SIZES: 3/4" ID (19.0 mm)

**WARNING:** Pressure, temperature, chemicals, and operating environment can affect the performance of couplings. It is the customer's responsibility to test the suitability of CPC's products in their own application conditions.

The MPU's twist-to-connect design features an easy-to-use locking mechanism that guards against accidental disconnects and provides a reliable, secure connection. A 3/4" hose barb provides smooth, rapid media transfer.

## FEATURES

3/4" hose barb

Locking feature

Sharp barb end

Shrouded, leak-free seal & smooth, internal flow path

ADCF-free materials

## BENEFITS

Facilitates rapid fill and empty of bioprocessing bags

Guards against accidental disconnects

Minimizes fluid turbulence and dead space

Protect valuable fluids and eliminate potential to contaminate fluid path

Meet BSE/TSE requirements

These graphs are intended to give you a general idea of the performance capabilities of each product line. The shaded area of each graph represents the operating range of the product family, i.e., upper and lower values are shown. Therefore, depending on the exact coupling configurations selected, you can reasonably expect values to fall within the shaded area.

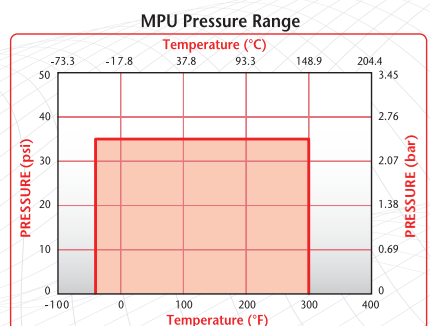
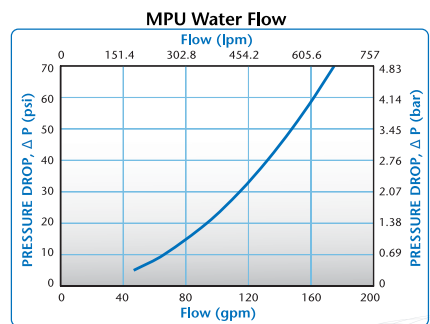

# MPU SERIES CONNECTOR DIMENSIONS

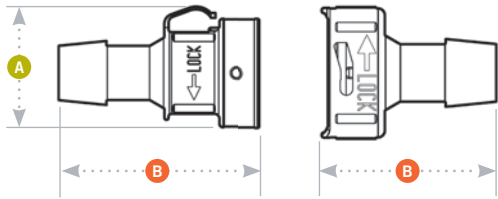

**A** = Height/Diameter  
**B** = Total Length



## Coupling Bodies • POLYSULFONE

	<b>TERMINATION</b> IN-LINE HOSE BARB	<b>TUBING</b> 3/4" ID	<b>METRIC EQ.</b> 19.0mm ID	<b>FLOW</b> .71"	<b>STRAIGHT THRU</b> MPU171239	<b>A</b> 1.75 (44.5)	<b>B</b> 2.37 (60.2)
---	---	--------------------------	--------------------------------	---------------------	-----------------------------------	-------------------------	-------------------------

## Coupling Inserts • POLYSULFONE

	<b>TERMINATION</b> IN-LINE HOSE BARB	<b>TUBING</b> 3/4" ID	<b>METRIC EQ.</b> 19.0mm ID	<b>FLOW</b> .71"	<b>STRAIGHT THRU</b> MPU221239M	<b>O-RING</b> Silicone Seal USP Class VI	<b>A</b> 1.56 (39.6)	<b>B</b> 2.88 (73.2)
---	---	--------------------------	--------------------------------	---------------------	------------------------------------	---	-------------------------	-------------------------

## Accessories • POLYSULFONE

	<b>SEALING CAP</b> MPU32039				<b>MATERIAL</b> Polysulfone USP Class VI	<b>A</b> 1.75 (44.5)	<b>B</b> .79 (20.1)
	<b>SEALING PLUG</b> MPU30039M		<b>O-RING</b> Silicone Seal		<b>MATERIAL</b> Polysulfone USP Class VI	<b>A</b> 1.56 (39.6)	<b>B</b> 1.38 (35.1)

All measurements are in inches (millimeters) unless otherwise noted. Tubing must meet stated inside and outside diameters.

# HFC39 SERIES CONNECTOR



## Specifications ● ● ●

### PRESSURE:

Vacuum to 125 psi, 8.6 bar

### TEMPERATURE:

-40°F to 280°F (-40°C to 138°C)

### MATERIALS:

#### Main components:

Polysulfone (amber tint), USP Class VI, ADCF

**O-rings:** Silicone (clear), platinum-cured, USP Class VI, ADCF

**Springs:** 316L stainless steel

### STERILIZATION:

**Gamma:** Up to 50 kGy irradiation. Sterilize coupled or uncoupled.

**Autoclave:** Up to 270°F (132°C) for 60 minutes. Up to 25 repetitions for uncoupled units and up to one repetition for coupled units.

### TERMINATION SIZES:

1/4", 3/8" and 1/2" ID hose barb  
(6.4mm, 9.5mm and 12.7mm)

**HFC39 Series sterile disconnect couplings** prevent external organisms from entering into the media flow path upon disconnection. Automatic shutoff valves close off the flow path aseptically protecting valuable media while also eliminating the need for pinch clamps and tube welders. The easy-to-use thumb latch design provides a secure, leak-free connection and enables one-hand disconnects.

## FEATURES

Simple one-step disconnection

Automatic shutoff valves

CPC Click

Lightweight

ADCF-free materials

## BENEFITS

Maintains media sterility in each half by preventing external organisms from entering the flow path

Stop flow and eliminate need for pinch clamps

Audible confirmation of secure connection

Easy integration with single-use assemblies

Meet BSE/TSE requirements

⚠ These graphs are intended to give you a general idea of the performance capabilities of each product line. The shaded area of the graph represents the operating range of the product family, i.e. upper and lower values are shown. Therefore, depending on the exact coupling configurations selected, you can reasonably expect values to fall within the shaded area.

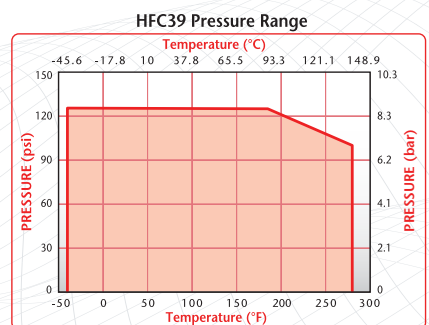
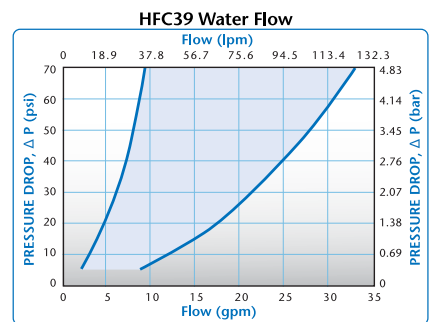

# HFC39 SERIES DIMENSIONS

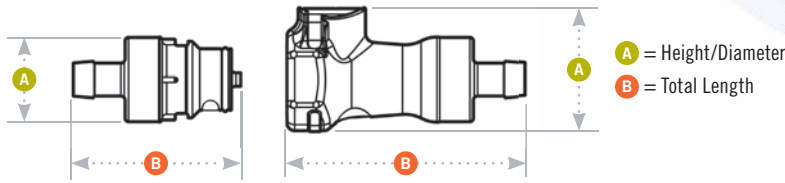

## Coupling Bodies • POLYSULFONE



**TERMINATION**  
**IN-LINE**  
**HOSE BARB**

TUBING SIZE	METRIC EQ.	FLOW	SHUTOFF	<span style="color: green;">A</span>	<span style="color: red;">B</span>
1/4" ID	6.4mm ID	1/4"	HFCD17439M	1.44 (36.6)	2.82 (71.6)
3/8" ID	9.5mm ID	3/8"	HFCD17639M	1.44 (36.6)	2.82 (71.6)
1/2" ID	12.5mm ID	1/2"	HFCD17839M	1.44 (36.6)	2.82 (71.6)

## Coupling Inserts • POLYSULFONE



**TERMINATION**  
**IN-LINE**  
**HOSE BARB**

TUBING SIZE	METRIC EQ.	FLOW	STRAIGHT THRU	SHUTOFF	<span style="color: green;">A</span>	<span style="color: red;">B</span>
1/4" ID	6.4mm ID	1/4"	HFC22439M	HFCD22439M	1.00 (25.4)	2.02 (51.3)
3/8" ID	9.5mm ID	3/8"	HFC22639M	HFCD22639M	1.00 (25.4)	2.02 (51.3)
1/2" ID	12.5mm ID	1/2"	HFC22839M	HFCD22839M	1.00 (25.4)	2.02 (51.3)

## Mating Parts



SEALING CAP	O-RING	MATERIAL	<span style="color: green;">A</span>	<span style="color: red;">B</span>
HFC32039		Polysulfone	1.44 (36.6)	2.73 (69.3)
SEALING PLUG				
HFC30039M	Silicone Seal USP Class VI	Polysulfone	1.00 (25.4)	1.81 (46.0)

All measurements are in inches (millimeters) unless otherwise noted. Tubing must meet stated inside and outside diameters. Couplings are pictured with valves unless otherwise noted.

For validation reports,  
visit [cpcworldwide.com/bio](http://cpcworldwide.com/bio)  
and for extractables data  
contact  
[info@cpcworldwide.com](mailto:info@cpcworldwide.com)

# ASEPTIQUIK® S SERIES CONNECTORS

## Specifications ● ● ●

### PRESSURE:

Up to 60 psi, 4.1 bar

### TEMPERATURE:

39°F to 104°F (4°C to 40°C)

### STERILIZATION:

**Gamma:** Up to 50kGy irradiation

**AutoClave High Temp (HT) Version:**

Up to 266°F (130°C) for 60 minutes

### TERMINATION SIZES:

1/8", 1/4" and 3/8" ID hose barb (3.2mm, 6.4mm and 9.5mm), 3/4" sanitary and MPC insert

### MATERIALS:

#### Main Components:

Polycarbonate (white), USP Class VI, ADCF

#### Pull Tabs/Caps:

Polycarbonate (blue, standard version),  
USP Class VI, ADCF

Polycarbonate (white, HT version),  
USP Class VI, ADCF

#### Seals:

Silicone (clear), platinum-cured,  
USP Class VI, ADCF

#### Membrane:

Polyethylene (standard version),  
USP Class VI, ADCF

Hydrophobic polyethersulfone (HT version),  
USP Class VI, ADCF, PTFE strip sticker

## AseptiQuik® S Small Format 1/8" and 1/4" Connectors

provide quick and easy sterile connections for small-flow applications, even in non-sterile environments. The "FLIP-CLICK-PULL" design of AseptiQuik S enables users to easily transfer small volumes of media with less risk of operator error. The connector's genderless and robust design provides reliable performance without the need for clamps, fixtures or tube welders. Biopharmaceutical manufacturers can now make 1/8" and 1/4" sterile connections with the quality and market availability they expect from the leader in single-use connection technology.

### FEATURES

Genderless design

FLIP-CLICK-PULL

Integrated pull tab covers

Robust construction

CPC Click

### BENEFITS

Eases single-use systems specifications with one part number for both halves

Intuitive three-step connection process reduces risk of operator error

Provide pre-assembly protection and ensure simultaneous removal of both membranes

Repeatable and reliable performance with no additional hardware required

Audible confirmation of assembly

⚠ This graph is intended to give you a general idea of the performance capabilities of each product line. The shaded area of the graph represents the operating range of the product family, i.e. upper and lower values are shown. Therefore, depending on the exact coupling configurations selected, you can reasonably expect values to fall within the shaded area.

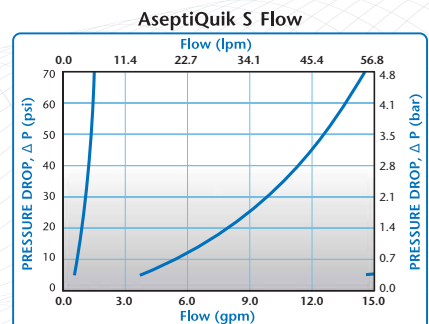

# ASEPTIQUIK® S SERIES DIMENSIONS

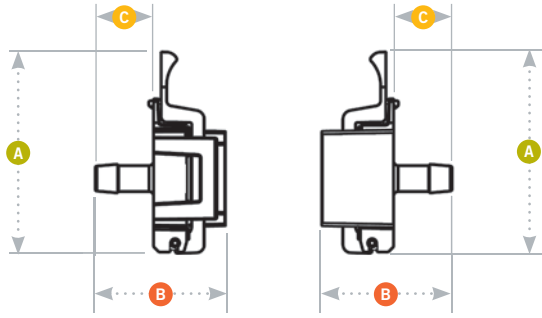

- A** = Height/Diameter
- B** = Total Length
- C** = Hose Barb Length

For validation reports, visit [cpcworldwide.com/bio](http://cpcworldwide.com/bio) and for extractables data, contact [info@cpcworldwide.com](mailto:info@cpcworldwide.com)

## Coupling Bodies

### • POLYCARBONATE with Blue Pull Tabs



**TERMINATION**  
 1/8" HOSE BARB  
 1/4" HOSE BARB  
 3/8" HOSE BARB  
 3/4" SANITARY  
 MPC INSERT

**PART NO.**  
 AQS17002  
 AQS17004  
 AQS17006  
 AQS33012  
 AQS17MPC

**A**  
 2.25  
 2.25  
 2.25  
 2.25  
 2.25

**B**  
 1.30  
 1.45  
 1.45  
 1.60  
 1.49

**C**  
 0.50  
 0.65  
 0.65  
 0.80  
 0.69

### • POLYCARBONATE HT with White Pull Tabs



**TERMINATION**  
 1/8" HOSE BARB  
 1/4" HOSE BARB  
 3/8" HOSE BARB  
 3/4" SANITARY  
 MPC INSERT

**PART NO.**  
 AQS17002HT  
 AQS17004HT  
 AQS17006HT  
 AQS33012HT  
 AQS17MPCHT

**A**  
 2.25  
 2.25  
 2.25  
 2.25  
 2.25

**B**  
 1.30  
 1.45  
 1.45  
 1.60  
 1.49

**C**  
 0.50  
 0.65  
 0.65  
 0.80  
 0.69

## FLIP-CLICK-PULL Assembly Procedure

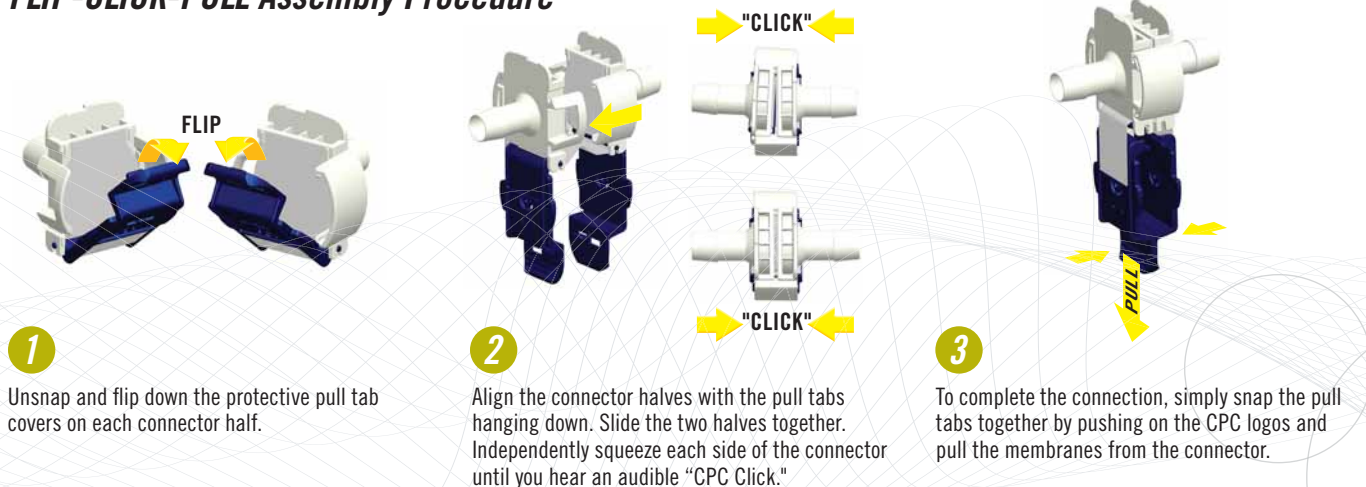

**1**  
 Unsnap and flip down the protective pull tab covers on each connector half.

**2**  
 Align the connector halves with the pull tabs hanging down. Slide the two halves together. Independently squeeze each side of the connector until you hear an audible "CPC Click."

**3**  
 To complete the connection, simply snap the pull tabs together by pushing on the CPC logos and pull the membranes from the connector.

# ASEPTIQUIK® G SERIES CONNECTORS



## Specifications ● ● ●

### PRESSURE:

Up to 60 psi, 4.1 bar  
Up to 75 psi, 5.1 bar for 48 hours

### TEMPERATURE:

34°F to 104°F (1°C to 40°C)

### STERILIZATION:

**Gamma:** Up to 50kGy irradiation

**Autoclave High Temp (HT) Version:**

Up to 266°F (130°C) for 60 minutes

### TERMINATION SIZES:

1/4", 3/8", 1/2", 3/4" ID hose barb (6.4mm, 9.5mm, 12.7mm, 19.0mm) and 3/4" sanitary

### MATERIALS:

#### Main Components:

Polycarbonate (white), USP Class VI, ADCF

#### Pull Tabs/Caps:

Polycarbonate (blue, standard version),

USP Class VI, ADCF

Polycarbonate (white, HT version),

USP Class VI, ADCF

#### Seals:

Silicone (clear), platinum-cured, USP Class VI, ADCF

#### Membrane:

Polyethylene (standard version), USP Class VI, ADCF

Hydrophobic polyethersulfone (HT version),

USP Class VI, ADCF, PTFE strip sticker

**Genderless AseptiQuik® G Connectors** enable quick and easy sterile connections, even in non-sterile environments. The easy-to-use genderless design simplifies system integration and minimizes the risk of operator error. The connectors' robust construction provides enhanced user confidence and reliable performance without the need for clamps, fixtures or tube welders. Biopharmaceutical manufacturers benefit from a full range of interchangeable 1/4" to 3/4" flow solutions with the quality and market availability they expect from the leader in single-use connection technology.

*Genderless interface allows easy transition between multiple tubing sizes from 1/4" to 3/4".*

⚠ This graph is intended to give you a general idea of the performance capabilities of each product line. The shaded area of the graph represents the operating range of the product family, i.e. upper and lower values are shown. Therefore, depending on the exact coupling configurations selected, you can reasonably expect values to fall within the shaded area.

**AseptiQuik G Flow**

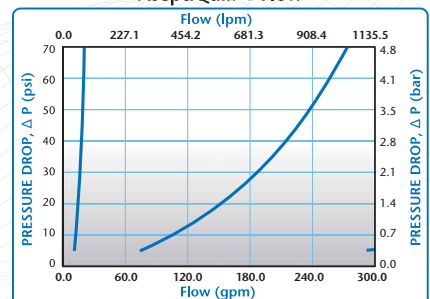

## FEATURES

Genderless design

Robust construction

FLIP-CLICK-PULL

Integrated pull tab covers

CPC Click

## BENEFITS

Eases integration of single-use systems with one part number for both halves

Repeatable and reliable performance with no additional hardware required

Innovative three-step connection process reduces risk of operator error

Pull tabs act as protective cover reducing part complexity and ensure simultaneous removal of both membranes

Audible confirmation of assembly

# ASEPTIQUIK® G SERIES DIMENSIONS

- A** = Height/Diameter
- B** = Total Length
- C** = Hose Barb Length

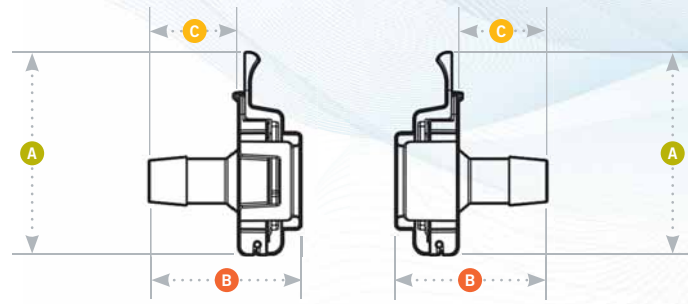

## Coupling Bodies

### • POLYCARBONATE with Blue Pull Tabs



TERMINATION	PART NO.	A	B	C
1/4" HOSE BARB	AQG17004	2.62	1.62	0.82
3/8" HOSE BARB	AQG17006	2.62	1.62	0.82
1/2" HOSE BARB	AQG17008	2.62	1.95	1.15
3/4" HOSE BARB	AQG17012	2.62	2.36	1.56
3/4" SANITARY	AQG33012	2.62	1.66	0.86

### • POLYCARBONATE HT with White Pull Tabs



TERMINATION	PART NO.	A	B	C
1/4" HOSE BARB	AQG17004HT	2.62	1.62	0.82
3/8" HOSE BARB	AQG17006HT	2.62	1.62	0.82
1/2" HOSE BARB	AQG17008HT	2.62	1.95	1.15
3/4" HOSE BARB	AQG17012HT	2.62	2.36	1.56
3/4" SANITARY	AQG33012HT	2.62	1.66	0.86

Validation reports  
are available at  
[cpcworldwide.com/bio](http://cpcworldwide.com/bio).

## FLIP-CLICK-PULL Assembly Procedure

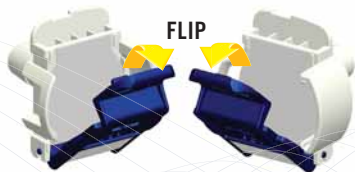

1

Unsnap and flip down the protective pull tab covers on each connector half.

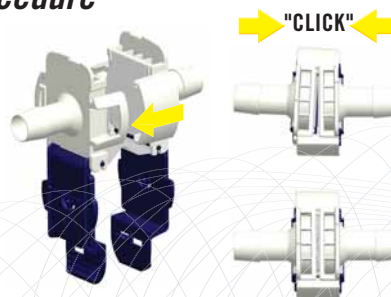

2

Align the connector halves with the pull tabs hanging down. Slide the two halves together. Independently squeeze each side of the connector until you hear an audible "CPC Click."

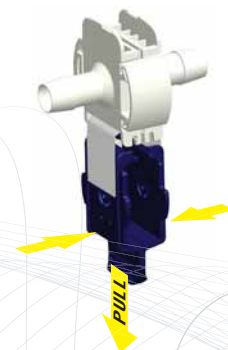

3

To complete the connection, simply snap the pull tabs together by pushing on the CPC logos and pull the membranes from the connector.



# ASEPTIQUIK® C SERIES CONNECTORS

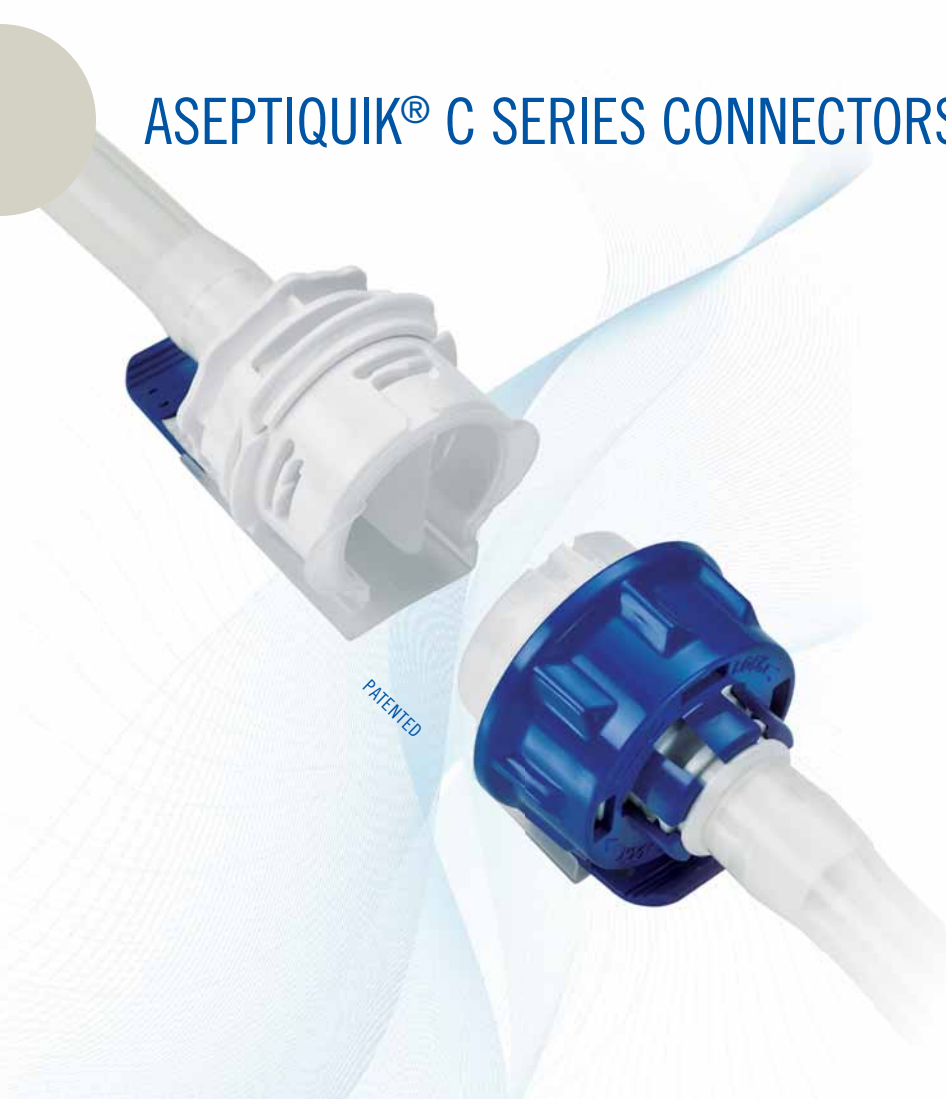

**AseptiQuik® C Connectors** provide quick and easy sterile connections, even in non-sterile environments. AseptiQuik's "CLICK-PULL-TWIST" design enables users to transfer media easily with less risk of operator error. The connector's robust design provides reliable performance without the need for clamps, fixtures or tube welders. Biopharmaceutical manufacturers can make sterile connections with the quality and market availability they expect from the leader in single-use connection technology.

## Specifications ● ● ●

### PRESSURE:

Up to 60 psi, 4.1 bar

### TEMPERATURE:

39°F to 104°F (4°C to 40°C)

### TYPICAL FLOW RATE:

Cv = 14.4 max

### STERILIZATION:

**Gamma:** Up to 50kGy irradiation

**Autoclave High Temp (HT) Version:**  
Up to 266°F (130°C) for 30 minutes

### TERMINATION SIZES:

3/8" (9.5mm) and 1/2" (12.7mm) ID hose barb, and 3/4" sanitary

### MATERIALS:

#### Main Components:

Polycarbonate (white), USP Class VI, ADCF

#### Lock Ring:

Polycarbonate (blue), USP Class VI, ADCF

#### Pull Tabs:

Polycarbonate (blue, standard version),  
USP Class VI, ADCF

Polycarbonate (white, HT version),  
USP Class VI, ADCF

#### Caps:

Polypropylene (clear), USP Class VI, ADCF

#### Seals:

Silicone (clear), platinum-cured, USP Class VI,  
ADCF

#### Membrane:

Polyethylene (standard version),  
USP Class VI, ADCF

Hydrophobic polyethersulfone (HT version),  
USP Class VI, ADCF

## FEATURES

CLICK-PULL-TWIST design

Membrane pull tabs

Robust construction

Integrated lock ring

CPC Click

Market availability

## BENEFITS

Intuitive three-step connection process reduces risk of operator error

Ensure simultaneous and secure removal of both membranes

Repeatable and reliable performance with no additional hardware required

Secures final connection preventing disassembly

Audible confirmation of completed assembly steps

Open access through multiple supply chain partners

*This graph is intended to give you a general idea of the performance capabilities of each product line. The shaded area of the graph represents the operating range of the product family, i.e. upper and lower values are shown. Therefore, depending on the exact coupling configurations selected, you can reasonably expect values to fall within the shaded area.*

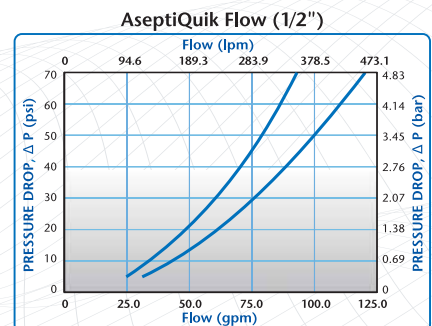

# ASEPTIQUIK® C SERIES DIMENSIONS

- A** = Height/Diameter
- B** = Total Length
- C** = Hose Barb Length

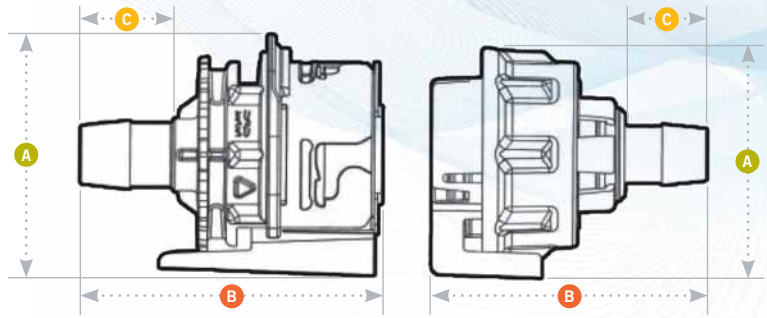

## Coupling Bodies

### • POLYCARBONATE with Blue Pull Tabs

TERMINATION	PART NO.	FLOW	A	B	C
3/8" HOSE BARB	AQC17006	.34	2.36 (59.9)	2.74 (69.6)	0.65 (16.5)
1/2" HOSE BARB	AQC17008	.50	2.36 (59.9)	2.95 (74.9)	0.89 (22.6)
3/4" SANITARY	AQC33012	.50	2.36 (59.9)	2.73 (69.3)	0.70 (17.8)

### • POLYCARBONATE HT with White Pull Tabs

TERMINATION	PART NO.	FLOW	A	B	C
3/8" HOSE BARB	AQC17006HT	.34	2.36 (59.9)	2.74 (69.6)	0.65 (16.5)
1/2" HOSE BARB	AQC17008HT	.50	2.36 (59.9)	2.95 (74.9)	0.89 (22.6)
3/4" SANITARY	AQC33012HT	.50	2.36 (59.9)	2.73 (69.3)	0.70 (17.8)

## Coupling Inserts

### • POLYCARBONATE with Blue Pull Tabs

TERMINATION	PART NO.	FLOW	A	B	C
3/8" HOSE BARB	AQC22006	.34	2.50 (63.5)	2.90 (73.7)	0.65 (16.5)
1/2" HOSE BARB	AQC22008	.50	2.50 (63.5)	2.99 (75.9)	0.89 (22.6)
3/4" SANITARY	AQC44012	.50	2.50 (63.5)	2.80 (71.1)	0.70 (17.8)

### • POLYCARBONATE HT with White Pull Tabs

TERMINATION	PART NO.	FLOW	A	B	C
3/8" HOSE BARB	AQC22006HT	.34	2.50 (63.5)	2.90 (73.7)	0.65 (16.5)
1/2" HOSE BARB	AQC22008HT	.50	2.50 (63.5)	2.99 (75.9)	0.89 (22.6)
3/4" SANITARY	AQC44012HT	.50	2.50 (63.5)	2.80 (71.1)	0.70 (17.8)

## CLICK-PULL-TWIST Assembly Procedure

- 1** Align male and female couplings, push together until "CPC Click" confirmation. Slight rotation of lock ring may be required for proper alignment prior to connection.
- 2** Snap membrane pull tabs together and pull from connector.
- 3** Twist the blue lock ring clock-wise until "CPC Click" and rib to arrow alignment confirms secure final connection.

# ASEPTIQUIK® DC SERIES CONNECTORS

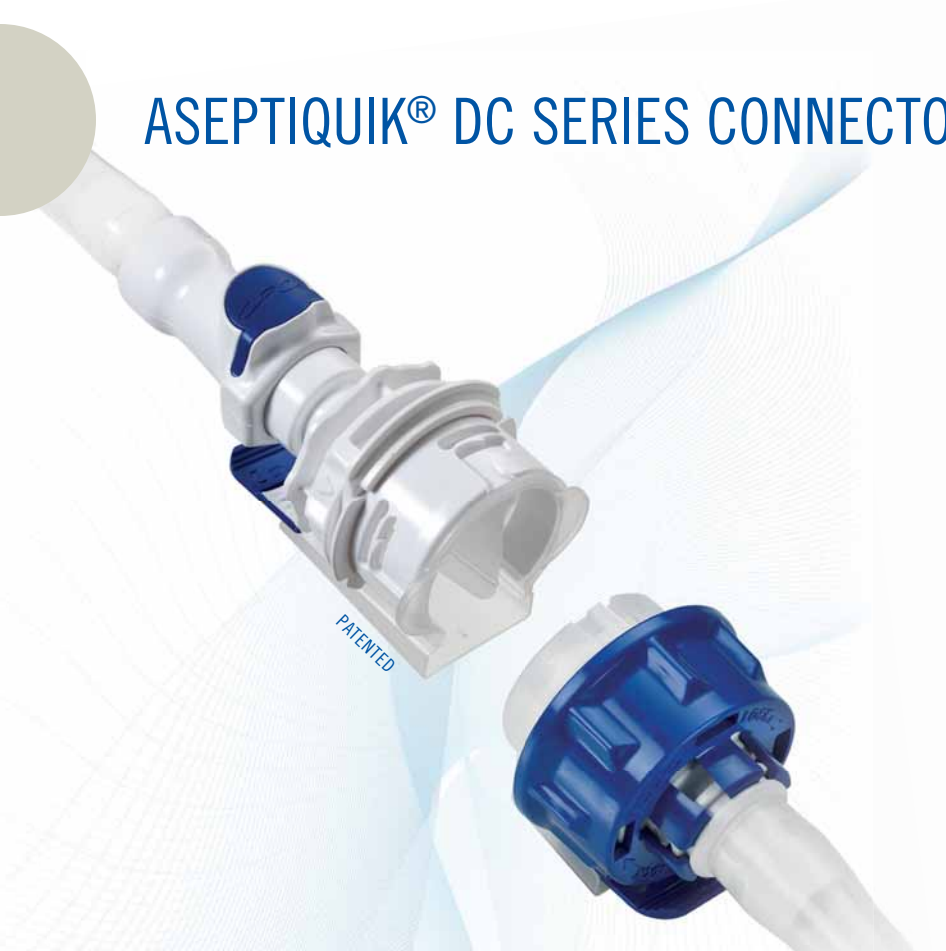

**AseptiQuik® DC Connectors** are the first all-in-one single-use connection technology to offer both a sterile connect and sterile disconnect. With the AseptiQuik DC Connector, manufacturers can make a quick and easy sterile connection and disconnection, even in non-sterile environments.

AseptiQuik DC's intuitive "CLICK-PULL-TWIST" design enables users to transfer media easily with less risk of operator error. After transfer is complete, the connector features a simple one-step disconnection that maintains media sterility by preventing external organisms from entering into the media flow path. The connector's robust design and automatic shutoff valves provide reliable performance without the need for sanitary clamps, fixtures or tube welders.

## FEATURES

CLICK-PULL-TWIST design

Simple one-step disconnection

Membrane pull tabs

Robust construction

CPC Click

Market availability

## BENEFITS

Intuitive three-step connection process reduces risk of operator error

Maintains media sterility in each half by preventing external organisms from entering the flow path

Ensure simultaneous and secure removal of both membranes

Repeatable and reliable performance with no additional hardware required

Audible confirmation of completed assembly steps

Open access through multiple supply chain partners

## Specifications ● ● ●

### PRESSURE:

Up to 60 psi, 4.1 bar

### TEMPERATURE:

39°F to 104°F (4°C to 40°C)

### STERILIZATION:

**Gamma:** Up to 50kGy irradiation

**Autoclave High Temp (HT) Version:** Up to 266°F (130°C) for 30 minutes

### TERMINATION SIZES:

1/4", 3/8" and 1/2" ID hose barb  
(6.4mm, 9.5mm and 12.7mm)

### MATERIALS:

**Main Components:** Polycarbonate (white), USP Class VI, ADCF

**Lock Ring:** Polycarbonate (blue), USP Class VI, ADCF

**Pull Tabs:**  
Polycarbonate (blue, standard version), USP Class VI, ADCF  
Polycarbonate (white, HT version), USP Class VI, ADCF

**Caps:** Polypropylene (clear), USP Class VI, ADCF

**Seals:** Silicone (clear), platinum-cured, USP Class VI, ADCF

**Membrane:**  
Polyethylene (standard version), USP Class VI, ADCF  
Hydrophobic polyethersulfone (HT version), USP Class VI, ADCF

**Springs:** 316L stainless steel

Mates with standard AseptiQuik halves:  
AQDC inserts mate with standard AQC bodies  
AQDC bodies mate with standard AQC inserts

This graph is intended to give you a general idea of the performance capabilities of each product line. The shaded area of the graph represents the operating range of the product family, i.e. upper and lower values are shown. Therefore, depending on the exact coupling configurations selected, you can reasonably expect values to fall within the shaded area.

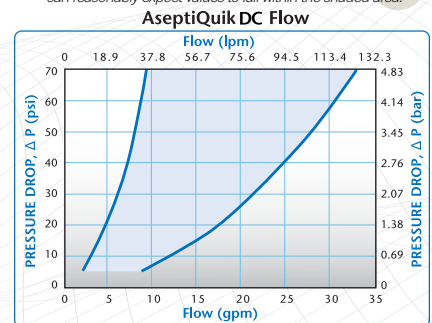

# ASEPTIQUIK® DC SERIES DIMENSIONS

- A** = Height/Diameter
- B** = Total Length
- C** = Hose Barb Length

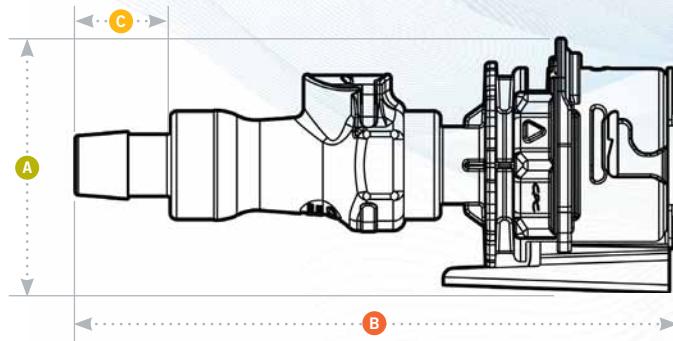

## Coupling Bodies • POLYCARBONATE



**TERMINATION**  
 1/4" HOSE BARB  
 3/8" HOSE BARB  
 1/2" HOSE BARB

**PART NO.**  
 AQCDC17004  
 AQCDC17006  
 AQCDC17008

**FLOW**  
 1/4"  
 3/8"  
 3/8"

**A**  
 2.36 (59.9)  
 2.36 (59.9)  
 2.36 (59.9)

**B**  
 5.33 (135.4)  
 5.33 (135.4)  
 5.62 (142.7)

**C**  
 0.60 (15.2)  
 0.60 (15.2)  
 0.89 (22.6)

## Coupling Inserts • POLYCARBONATE



**TERMINATION**  
 1/4" HOSE BARB  
 3/8" HOSE BARB  
 1/2" HOSE BARB

**PART NO.**  
 AQCDC22004  
 AQCDC22006  
 AQCDC22008

**FLOW**  
 1/4"  
 3/8"  
 3/8"

**A**  
 2.50 (63.5)  
 2.50 (63.5)  
 2.50 (63.5)

**B**  
 5.41 (137.4)  
 5.41 (137.4)  
 5.70 (144.8)

**C**  
 0.60 (15.2)  
 0.60 (15.2)  
 0.89 (22.6)

## CLICK-PULL-TWIST Assembly Procedure



**1**  
 Align male and female couplings, push together until audible "CPC Click" confirmation.  
 Slight rotation of lock ring may be required for proper alignment prior to connection.



**2**  
 Snap membrane pull tabs together and pull from connector.



**3**  
 Twist the blue lock ring clock-wise until "CPC Click" and rib to arrow alignment confirms secure final connection.

## To Disconnect

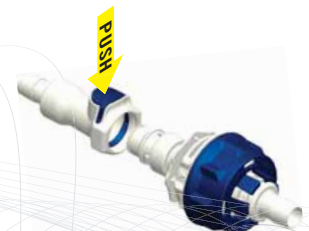

When fluid transfer is finished, press the thumb latch down to complete the sterile disconnection. Both halves will remain sterile.

# ASEPTIQUIK® X SERIES CONNECTORS



**AseptiQuik® X Large Format 1" Connectors** provide quick and easy sterile connections for high flow applications, even in non-sterile environments. AseptiQuik X's "TWIST-PULL-TWIST" design enables users to quickly transfer large volumes of media easily with less risk of operator error. The connector's robust design provides reliable performance without the need for clamps, fixtures or tube welders. Biopharmaceutical manufacturers can now make 1" sterile connections with the quality and market availability they expect from the leader in single-use connection technology.

## FEATURES

TWIST-PULL-TWIST Design

Membrane pull tabs

Robust construction

Integrated lock ring

CPC Click

## BENEFITS

Intuitive three-step connection process reduces risk of operator error

Ensure simultaneous and secure removal of both membranes

Repeatable and reliable performance with no additional hardware required

Secures final connection preventing disassembly

Audible confirmation of completed assembly steps

## Specifications ● ● ●

### PRESSURE:

Up to 60 psi, 4.1 bar

### TEMPERATURE:

39°F to 104°F (4°C to 40°C)

### STERILIZATION:

**Gamma:** Up to 50kGy irradiation

**Autoclave High Temp (HT) Version:** Up to 266°F (130°C) for 30 minutes

### TERMINATION SIZES:

3/4" and 1" ID hose barb (19.0mm and 25.4mm), 1-1/2" sanitary

### MATERIALS:

#### Main Components:

PVDF (white), USP Class VI, ADCF

#### Lock Ring:

PVDF (blue), USP Class VI, ADCF

#### Pull Tabs:

Polycarbonate (blue, standard version), USP Class VI, ADCF

Polycarbonate (white, HT version), USP Class VI, ADCF

#### Caps:

Polypropylene (clear), USP Class VI, ADCF

#### Seals:

Silicone (clear), platinum-cured, USP Class VI, ADCF

#### Membrane:

Polyethylene (standard version), USP Class VI, ADCF

Hydrophobic polyethersulfone (HT version), USP Class VI, ADCF, PTFE strip sticker

⚠ This graph is intended to give you a general idea of the performance capabilities of each product line. The shaded area of the graph represents the operating range of the product family, i.e. upper and lower values are shown. Therefore, depending on the exact coupling configurations selected, you can reasonably expect values to fall within the shaded area.

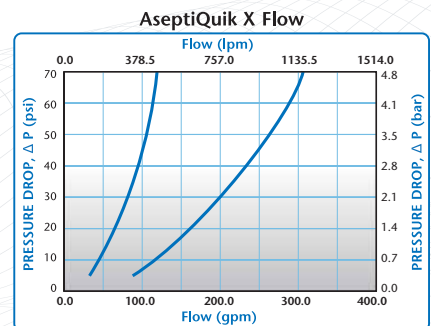

# ASEPTIQUIK® X SERIES DIMENSIONS

- A** = Height/Diameter
- B** = Total Length
- C** = Hose Barb Length

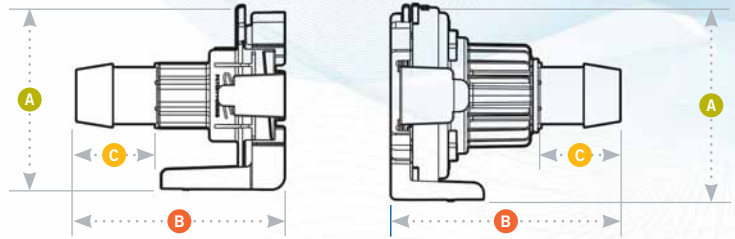

## Coupling Bodies

### • POLYCARBONATE with Blue Pull Tabs



**TERMINATION**  
 3/4" HOSE BARB  
 1" HOSE BARB  
 1-1/2" SANITARY

**PART NO.**  
 AQX17012  
 AQX17016  
 AQX33024

**A**  
 3.54  
 3.54  
 3.54

**B**  
 3.93  
 4.04  
 4.18

**C**  
 1.50  
 1.53  
 1.73

### • POLYCARBONATE HT with White Pull Tabs

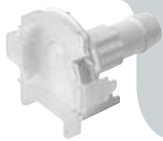

**TERMINATION**  
 3/4" HOSE BARB  
 1" HOSE BARB  
 1-1/2" SANITARY

**PART NO.**  
 AQX17012HT  
 AQX17016HT  
 AQX33024HT

**A**  
 3.54  
 3.54  
 3.54

**B**  
 3.93  
 4.04  
 4.18

**C**  
 1.50  
 1.53  
 1.73

## Coupling Inserts

### • POLYCARBONATE with Blue Pull Tabs



**TERMINATION**  
 3/4" HOSE BARB  
 1" HOSE BARB  
 1-1/2" SANITARY

**PART NO.**  
 AQX22012  
 AQX22016  
 AQX44024

**A**  
 3.76  
 3.76  
 3.76

**B**  
 4.34  
 4.45  
 4.58

**C**  
 1.50  
 1.53  
 1.74

### • POLYCARBONATE HT with White Pull Tabs



**TERMINATION**  
 3/4" HOSE BARB  
 1" HOSE BARB  
 1-1/2" SANITARY

**PART NO.**  
 AQX22012HT  
 AQX22016HT  
 AQX44024HT

**A**  
 3.76  
 3.76  
 3.76

**B**  
 4.34  
 4.45  
 4.58

**C**  
 1.50  
 1.53  
 1.74

## TWIST-PULL-TWIST Assembly Procedure

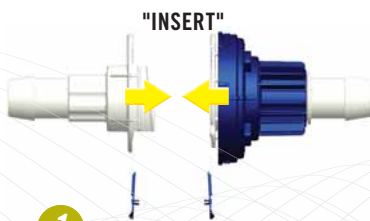

**1**

Align male and female connectors using the START alignment feature of the blue lock ring with the rib indicator of the white body. Insert the two halves together.



**2**

Twist the blue lock ring clockwise (approximately 75°) until audible "CPC Click" is heard. Alignment of the small blue lock ring rib indicator with the white body's rib indicator confirms final rotation is complete.



**3**

Snap the membrane pull tabs together and pull from connector.



**4**

Twist the blue lock ring clockwise until the final audible "CPC Click" is heard (90° from the initial starting point). Alignment of the long blue lock ring rib indicator with the white body's rib indicator confirms initial rotation is complete.

# STEAM-THRU® SERIES CONNECTOR



**Steam-Thru Connections** allow a quick and easy sterile connection between stainless steel biopharmaceutical processing equipment and disposable bag and tube assemblies. The single-use design saves time and money by eliminating unnecessary cleaning procedures and reducing validation burden associated with reusable components.

## FEATURES

Innovative three-port design

Patented valve design

Thumb latch/Tear-away sleeve

3/4" and 1-1/2" Terminations

ADCF-free materials

## BENEFITS

Allows a true steam-through SIP process which eliminates "dead legs" and the need for laminar flow hoods

Allows sterile connection and disconnection and permits high media flow rate

Secures valve position, provides visual indicator of process stage

Easily connects to process equipment

Meet BSE/TSE requirements

## Specifications ● ● ●

### PRESSURE:

**Steam position:**

Up to 30 psi, 2.1 bar (Steam-Thru)

Up to 35 psi, 2.4 bar (Steam-Thru II)

**Flow position:** Vacuum to 20 psi, 1.4 bar

### TEMPERATURE:

**Steam position:**

Up to 266°F (130°C) for 60 minutes (Steam-Thru)

Up to 275°F (135°C) for 60 minutes (Steam-Thru II)

**Flow position:** 39°F to 104°F (4°C to 40°C)

### MATERIALS:

**Connection:** Polysulfone (amber tint), USP Class VI, ADCF

**O-rings:** Silicone (clear), platinum-cured, USP Class VI, ADCF

**Tear-away sleeve:** Polyethylene or polycarbonate (Steam-Thru only), USP Class VI

### TYPICAL FLOW RATE:

$C_v = 4.2 - 4.6$  (Steam-Thru)

$C_v = 5.2 - 8.0$  (Steam-Thru II)

### STERILIZATION:

**Gamma:** Up to 50 kGy irradiation

**Autoclave:** Up to 265°F (129°C) for 60 minutes, up to two cycles (applies only to part numbers STC1700500-STC1700800 and STC2020000-STC2021000)

**SIP process:**

Up to 266°F (130°C) for 60 minutes (Steam-Thru)

Up to 275°F (135°C) for 60 minutes (Steam-Thru II)

### TERMINATION SIZES:

3/8" (9.5mm) to 1/2" (12.7mm) ID hose barb (Steam-Thru)

3/8" (9.5mm) to 1/2" (12.7mm) ID hose barb and 3/4" sanitary (Steam-Thru II)



These graphs are intended to give you a general idea of the performance capabilities of each product line. The shaded area of the graph represents the operating range of the product family, i.e. upper and lower values are shown. Therefore, depending on the exact coupling configurations selected, you can reasonably expect values to fall within the shaded area.

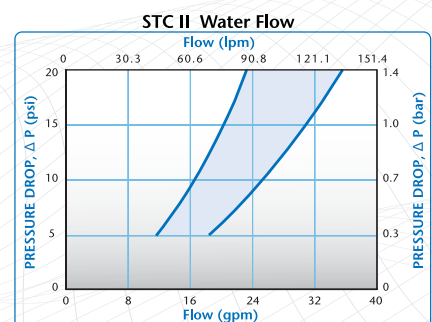
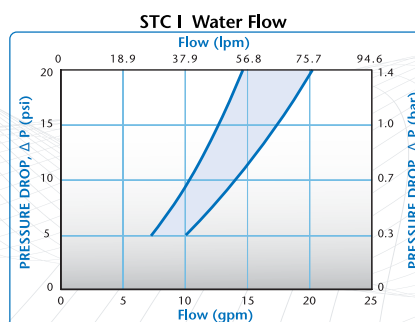

# STEAM-THRU SERIES DIMENSIONS

## Steam-Thru® Configurations

Steam-Thru Connection's patented three-port design allows steam to pass directly through the lower ports to "steam on" to stainless equipment. After the SIP cycle is completed, the connector's valve is actuated, creating a sterile flow path to single-use systems.

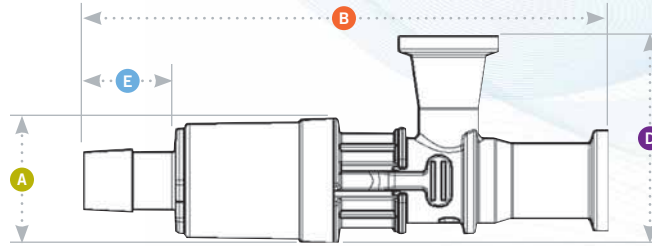

- A = Diameter
- B = Total Length
- C = Actuated Length
- D = Height
- E = Hose Barb Length

## Coupling Bodies • POLYSULFONE



**DESCRIPTION  
WITH POLYETHYLENE  
SLEEVE**

PART NO.	TERMINATIONS	A	B	C	D	E
STC1700000	3/4" x 3/4" sanitary x 1/2" HB	1.20 (30.5)	5.09 (129.3)	4.44 (112.8)	2.00 (50.8)	0.89 (22.6)
STC1700100	3/4" x 3/4" sanitary x 3/8" HB	1.20 (30.5)	4.80 (121.9)	4.15 (105.4)	2.00 (50.8)	0.60 (15.2)
STC1700200	3/4" x 1-1/2" sanitary x 1/2" HB	1.20 (30.5)	5.09 (129.3)	4.44 (112.8)	2.00 (50.8)	0.89 (22.6)
STC1700300	3/4" x 1-1/2" sanitary x 3/8" HB	1.20 (30.5)	4.80 (121.9)	4.15 (105.4)	2.00 (50.8)	0.60 (15.2)



**DESCRIPTION  
WITH  
AUTOCCLAVABLE  
POLYCARBONATE  
SLEEVE**

PART NO.	TERMINATIONS	A	B	C	D	E
STC1700500	3/4" x 3/4" sanitary x 1/2" HB	1.20 (30.5)	5.09 (129.3)	4.44 (112.8)	2.00 (50.8)	0.89 (22.6)
STC1700600	3/4" x 3/4" sanitary x 3/8" HB	1.20 (30.5)	4.80 (121.9)	4.15 (105.4)	2.00 (50.8)	0.60 (15.2)
STC1700700	3/4" x 1-1/2" sanitary x 1/2" HB	1.20 (30.5)	5.09 (129.3)	4.44 (112.8)	2.00 (50.8)	0.89 (22.6)
STC1700800	3/4" x 1-1/2" sanitary x 3/8" HB	1.20 (30.5)	4.80 (121.9)	4.15 (105.4)	2.00 (50.8)	0.60 (15.2)

## Steam-Thru II Configurations

Steam-Thru II Connections offer the flexibility of "steam on" and "steam off" functionality. The innovative design allows the valve to be returned to the steam position enabling a second SIP cycle following media transfer. The "steam off" disconnection of single-use systems minimizes cross-contamination risks associated with reusable components.

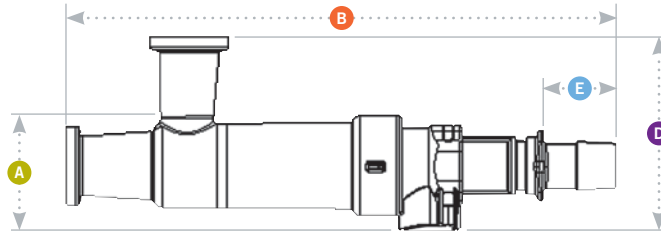

- A = Diameter
- B = Total Length
- C = Actuated Length
- D = Height
- E = Hose Barb Length

## Coupling Bodies • POLYSULFONE



**DESCRIPTION  
WITH  
POLYCARBONATE  
SLEEVE**

PART NO.	TERMINATIONS	A	B	C	D	E
STC2020000	3/4" x 3/4" sanitary x 1/2" HB	1.42 (36.1)	6.84 (173.7)	5.93 (150.6)	2.40 (61.0)	.88 (22.4)
STC2020100	3/4" x 3/4" sanitary x 3/8" HB	1.42 (36.1)	6.76 (171.7)	5.93 (150.6)	2.40 (61.0)	.80 (20.3)
STC2020200	3/4" x 1-1/2" sanitary x 1/2" HB	1.42 (36.1)	6.84 (173.7)	5.93 (150.6)	2.40 (61.0)	.88 (22.4)
STC2020300	3/4" x 1-1/2" sanitary x 3/8" HB	1.42 (36.1)	6.76 (171.7)	5.93 (150.6)	2.40 (61.0)	.80 (20.3)
STC2020900	3/4" x 3/4" sanitary x 3/4" sanitary	1.42 (36.1)	6.60 (167.6)	5.93 (150.6)	2.40 (61.0)	.62 (15.7)
STC2021000	3/4" x 1-1/2" sanitary x 3/4" sanitary	1.42 (36.1)	6.60 (167.6)	5.93 (150.6)	2.40 (61.0)	.62 (15.7)

All measurements are in inches (millimeters) unless otherwise noted. Tubing must meet stated inside and outside diameters.



# ASEPTIQUIK® STC SERIES CONNECTOR



**AseptiQuik® STC Connectors** integrate the AseptiQuik® sterile connector and the Steam-Thru® II SIP connector, giving manufacturers even greater flexibility for hybrid stainless steel and single-use processing. The AseptiQuik STC connector combines either an AseptiQuik G or AseptiQuik C sterile connector with a Steam-Thru II connection that can be mounted directly to a stainless steel vessel via a sanitary termination. AseptiQuik STC connectors utilizing an AseptiQuik G sterile connector offer a genderless design, simplifying system integration at the aseptic connector end. AseptiQuik STC connectors utilizing an AseptiQuik C sterile connector allow system designers to incorporate a keyed female-to-male connection at the aseptic connector end.

The union of the two connectors into a single unit through a sanitary clamp allows an AseptiQuik sterile connection to be steamed on to stainless equipment via SIP. After the SIP cycle, a wide range of single-use systems can be connected. The SIP process can be done in advance allowing a quick and easy sterile connection to the AseptiQuik half without having to wait 30-60 minutes for SIP prior to harvest.

## FEATURES

AseptiQuik design

Genderless design

Innovative three-port steam design

Robust construction

Patented steam valve design

Sanitary interface between the two connectors

CPC Click

Market availability

## BENEFITS

Innovative three-step connection process reduces risk of operator error

Eases integration of single-use systems with universal mating between AseptiQuik G Connectors

Allows a true steam-through SIP process which eliminates "dead legs"

Repeatable and reliable performance with no additional hardware required

Allows sterile connection and disconnection to stainless equipment and permits a high media flow rate.

More secure connection than tubing with cable ties

Audible confirmation of assembly steps

Open access through multiple supply chain partners

## Specifications ● ● ●

### PRESSURE:

**Steam position:** Up to 35 psi, 2.4 bar

**Flow position:** Up to 20 psi, 1.4 bar

### TEMPERATURE:

**Steam position:**

Up to 275°F (135°C) for 60 minutes

**Flow position:** 39°F to 104°F (4°C to 40°C)

### STERILIZATION:

**Gamma:** Up to 50kGy irradiation

**AutoClave:** High Temp (HT) version:

Up to 266°F (130°C) for 30 minutes (AQSTC)

Up to 266°F (130°C) for 60 minutes (AQGSTC)

*Note: A slight clockwise rotation of the clamp nut may be needed after autoclave.*

### MATERIALS:

**Main Components:**

**AseptiQuik** - Polycarbonate (white), USP Class VI, ADCF

**Steam-Thru II** - Polysulfone (amber tint), USP Class VI, ADCF

**Seals:** Silicone (clear), platinum-cured, USP Class VI, ADCF

**Pull Tabs:**

Polycarbonate (blue, standard version), USP Class VI, ADCF

Polycarbonate (white, HT version), USP Class VI, ADCF

**Caps:** Polypropylene (clear), USP Class VI, ADCF

**Membrane:**

Polyethylene (standard version), USP Class VI, ADCF

Hydrophobic polyethersulfone (HT versions), USP Class VI, ADCF, PTFE strip sticker

**Clamp:** Nylon 66 (white), USP Class VI

*Note: Mates with gendered and genderless AseptiQuik connectors.*

# ASEPTIQUIK® STC SERIES DIMENSIONS

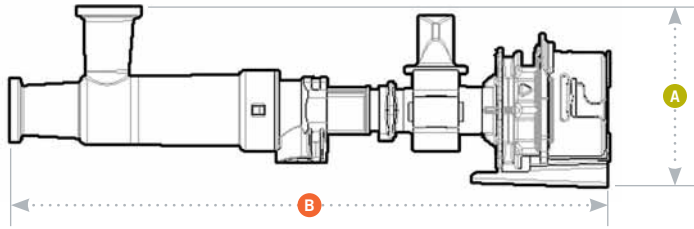

- A** = Height/Diameter
- B** = Total Length
- C** = Actuated Length

Mates with gendered male and female AseptiQuik Series.

## Coupling Bodies

- **POLYCARBONATE** with Blue Pull Tabs



**TERMINATION**  
3/4" X 3/4" SANITARY STEAM-THRU II WITH ASEPTIQUIK BODY

PART NO.	A	B	C
AQSTC2330900	2.78 (70.6 mm)	9.25 (235 mm)	8.42 (213.9 mm)

3/4" X 1-1/2" SANITARY STEAM-THRU II WITH ASEPTIQUIK BODY (PICTURED)

AQSTC2331000	2.78 (70.6 mm)	9.25 (235 mm)	8.42 (213.9 mm)
--------------	----------------	---------------	-----------------

- **POLYCARBONATE** HT with White Pull Tabs

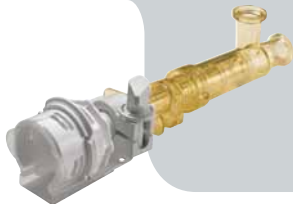

**TERMINATION**  
3/4" X 3/4" SANITARY STEAM-THRU II WITH ASEPTIQUIK BODY (PICTURED)

PART NO.	A	B	C
AQSTC2330900HT	2.78 (70.6 mm)	9.25 (235 mm)	8.42 (213.9 mm)

3/4" X 1-1/2" SANITARY STEAM-THRU II WITH ASEPTIQUIK BODY

AQSTC2331000HT	2.78 (70.6 mm)	9.25 (235 mm)	8.42 (213.9 mm)
----------------	----------------	---------------	-----------------

# ASEPTIQUIK® G STC SERIES DIMENSIONS

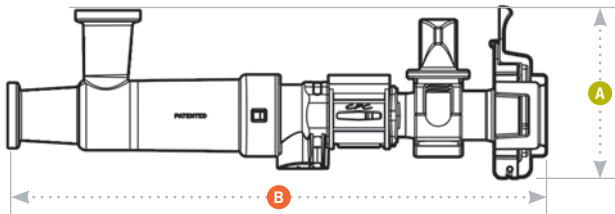

- A** = Height/Diameter
- B** = Total Length
- C** = Actuated Length

Mates with genderless AseptiQuik G Series.

## Coupling Bodies

- **POLYCARBONATE** with Blue Pull Tabs



**TERMINATION**  
3/4" X 3/4" SANITARY STEAM-THRU II WITH GENDERLESS ASEPTIQUIK G BODY

PART NO.	A	B	C
AQGSTC2330900	3.05	8.26	7.36

3/4" X 1-1/2" SANITARY STEAM-THRU II WITH GENDERLESS ASEPTIQUIK G BODY

AQGSTC2331000	3.05	8.26	7.36
---------------	------	------	------

- **POLYCARBONATE** HT with White Pull Tabs

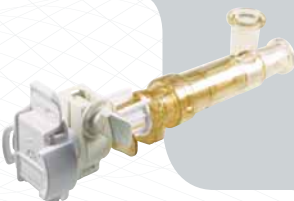

**TERMINATION**  
3/4" X 3/4" SANITARY STEAM-THRU II WITH GENDERLESS ASEPTIQUIK G BODY

PART NO.	A	B	C
AQGSTC2330900HT	3.05	8.26	7.36

3/4" X 1-1/2" SANITARY STEAM-THRU II WITH GENDERLESS ASEPTIQUIK G BODY

AQGSTC2331000HT	3.05	8.26	7.36
-----------------	------	------	------

# ASEPTIQUIK® STC SERIES ASSEMBLY PROCEDURE

## CLICK-PULL-TWIST Assembly Procedure

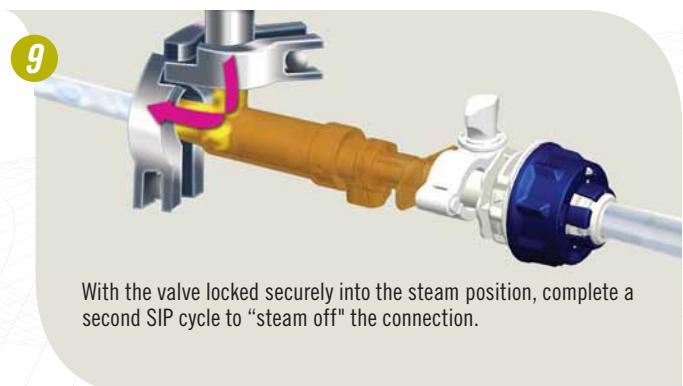
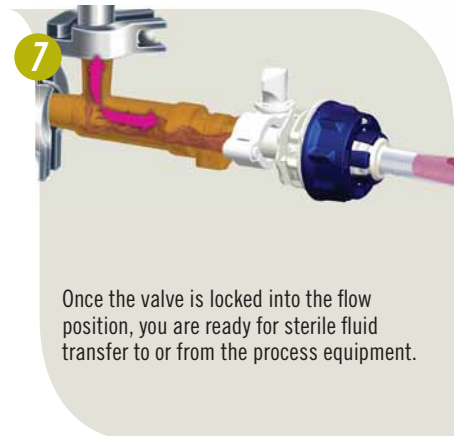
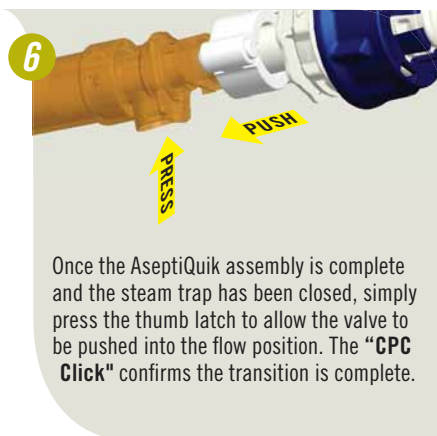
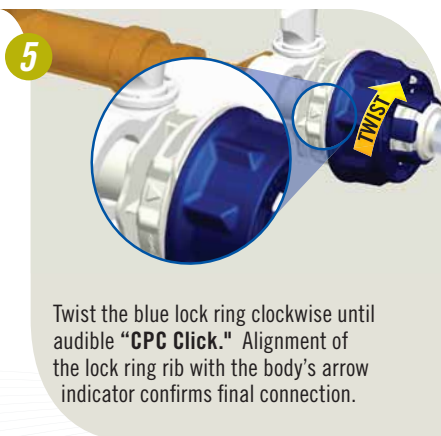
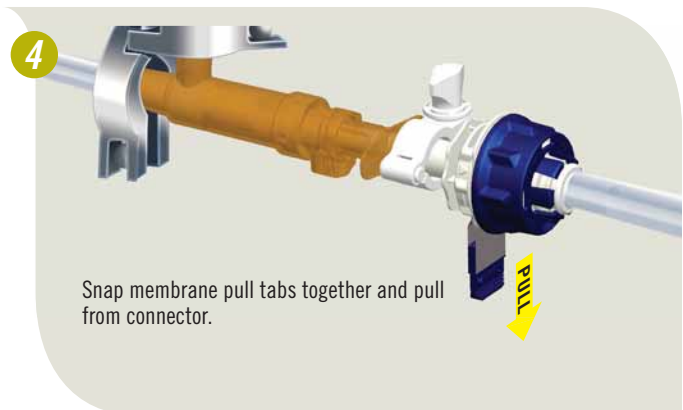
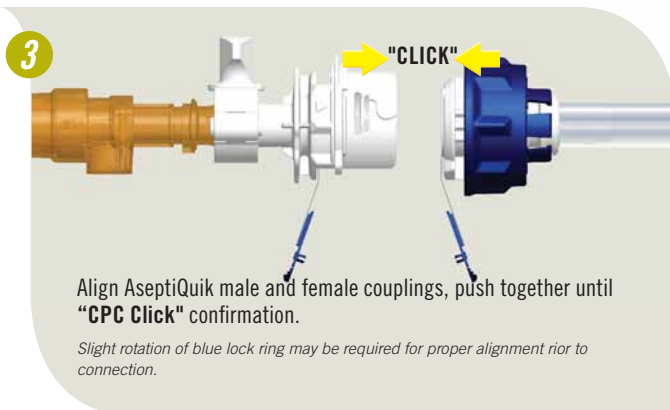
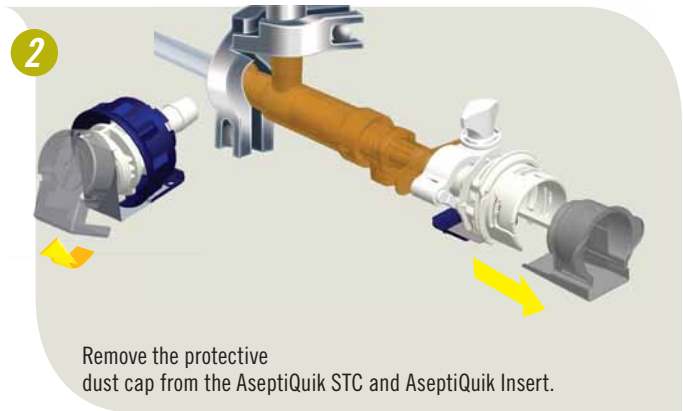
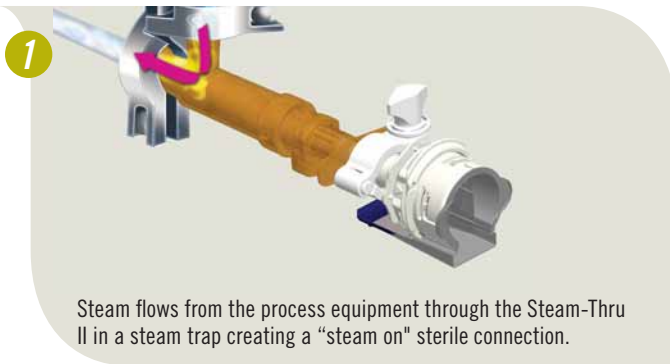

# ASEPTIQUIK® G STC SERIES ASSEMBLY PROCEDURE

## FLIP-CLICK-PULL Assembly Procedure

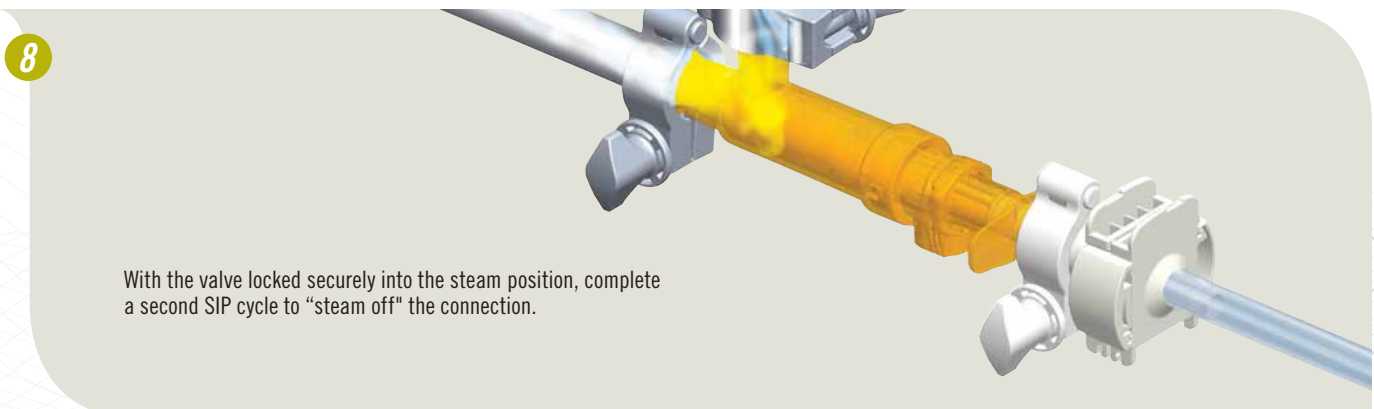
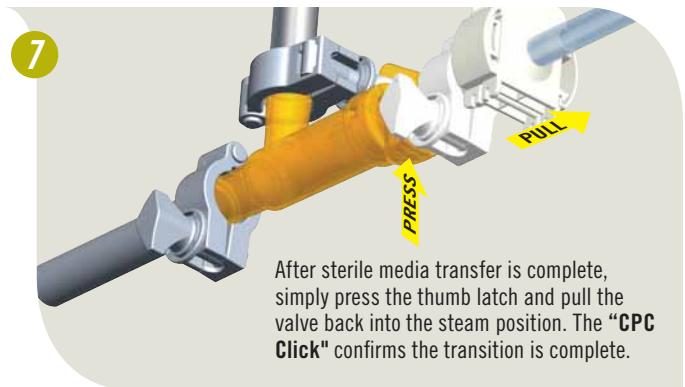
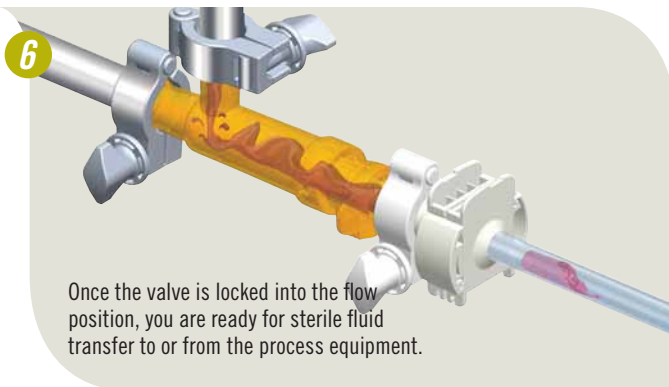
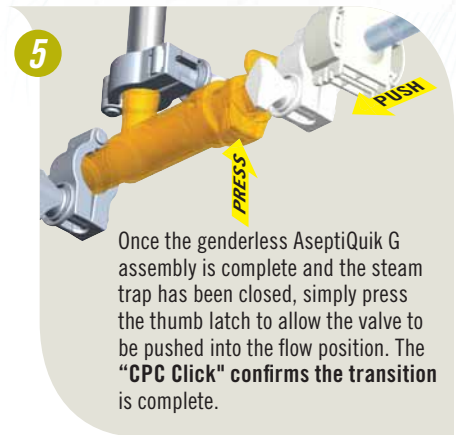
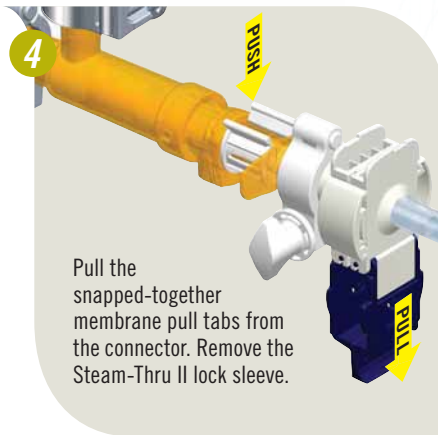
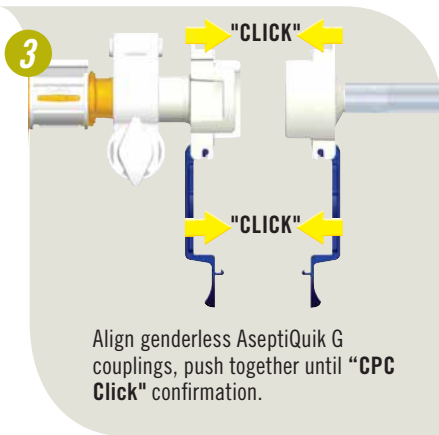
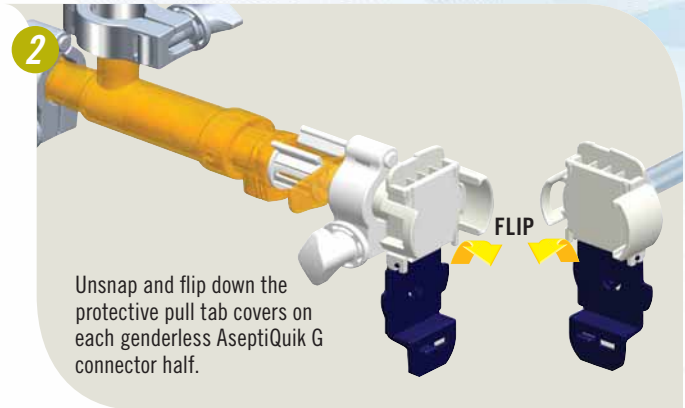
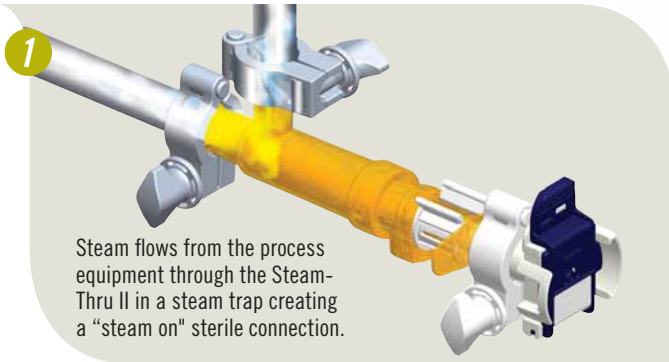

# REGULATORY AND COMPLIANCE

## ***ISO 13485:2003 Certification***

ISO 13485:2003 is recognized by regulators around the world as a good basis for addressing medical device design and manufacturing regulatory requirements. It allows us to enhance product safety by proactively identifying and managing product and project risks. Becoming ISO 13485:2003 certified has allowed us to better control the consistency of manufactured products.

## ***ISO 9001:2008 Certification***

ISO 9001:2008 is a standard which assures consistency of a product ordered by customers. Organizations having ISO 9001:2008 certification have demonstrated compliance to the ISO 9001:2008 requirements by an independent registration authority. CPC's Quality Management System has been approved and certified under the ISO 9001:2008 standard.

## ***Cleanroom Manufacturing***

CPC manufactures certain Life Sciences and Chemical Management product lines in a cleanroom certified by an external testing service to meet or exceed ISO Class 7 (10,000) at 0.5 mm per ISO 14644 and the former Federal Standard 209E. Certification data is available upon request.

## ***Animal Derived Component Free (ADCF)***

According to declarations from CPC's raw material suppliers, the materials used to manufacture the flow path components of the biopharmaceutical product lines do not contain substances of animal origin.

## ***FDA and USDA***

The U.S. Food and Drug Administration publishes, through the Code of Federal Regulations, standardized criteria which govern the acceptability of materials used in food contact. The U.S. Department of Agriculture publishes similar standards that mirror FDA criteria. Neither agency approves or disapproves products for particular applications. Most of CPC's products are made using resins that comply with applicable FDA or USDA standards. When necessary, the standard o-ring seals are replaced with specific, recognized materials.

## ***REACH***

REACH is the Regulation for Registration, Evaluation, Authorisation and Restriction of Chemicals. It entered into force on 1st June 2007 to streamline and improve the former legislative framework on chemicals of the European Union (EU). REACH places greater responsibility on industry to manage the risks that chemicals may pose to the health and the environment. CPC publishes a list of CPC products that are compliant with the EU regulation 1907/2006.

## ***Regulation of Hazardous Substances***

The RoHS Directive stands for "the restriction of the use of certain hazardous substances in electrical and electronic equipment." This Directive bans the placing on the EU market of new electrical and electronic equipment containing more than agreed levels of lead, cadmium, mercury, hexavalent chromium, polybrominated biphenyl (PBB) and polybrominated diphenyl ether (PBDE) flame retardants.



Distributed by:

**COLDER PRODUCTS COMPANY**  
1001 WESTGATE DRIVE  
ST. PAUL, MINNESOTA 55114  
U.S.A.

**PHONE:** +1 651-645-0091  
**FAX:** +1 651-645-5404  
**TOLL FREE:** 800-444-2474  
info@cpcworldwide.com  
cpcworldwide.com

**COLDER PRODUCTS COMPANY GMBH**  
OSTRING 19  
D-63762 GROSSOSTHEIM  
GERMANY

**PHONE:** +49-6026-9973-0  
**FAX:** +49-6026-9973-173

cpcgmbh@cpcworldwide.com  
cpcworldwide.com

**COLDER PRODUCTS COMPANY LIMITED**  
FLAT B, 29/F, WEST GATE TOWER,  
7 WING HONG STREET, CHEUNG SHA WAN  
KOWLOON, HONG KONG

**PHONE:** +852-2987-5272  
**FAX:** +852-2987-2509

asiapacific@cpcworldwide.com  
cpcworldwide.com



**CPC WARRANTY STATEMENT:** CPC (Colder Products Company) warrants its products against defects in workmanship and materials for a period of 12 months from the date of sale by CPC to its initial customer (regardless of any subsequent sale of the products). This warranty is void if the product is misused, altered, tampered with or is installed or used in a manner that is inconsistent with CPC's written recommendations, specifications and/or instructions, or fails to perform due to normal wear and tear. CPC does not warrant the suitability of the product for any particular application. Determining product application suitability is solely the customer's responsibility. CPC is not liable for special, indirect, incidental, consequential or other damages including, but not limited to, loss, damage, personal injury, or any other expense directly or indirectly arising from the use of or inability to use its products either separately or in combination with other products. **ALL OTHER WARRANTIES EXPRESS OR IMPLIED, WHETHER ORAL, WRITTEN OR IN ANY OTHER FORM, INCLUDING BUT NOT LIMITED TO WARRANTIES OF MERCHANTABILITY OR FITNESS FOR A PARTICULAR PURPOSE, ARE EXPRESSLY EXCLUDED.** The sole and exclusive remedy under this warranty is limited, at the option of CPC, to replacement of the defective product or an account credit in the amount of the original selling price. All allegedly defective CPC products must be returned prepaid transportation to CPC, together with information describing the product's application and performance, unless otherwise authorized in writing by CPC.

**CPC PATENT STATEMENT:** CPC takes pride in its innovative quick disconnect coupling and fittings solutions, many of which have been awarded United States and international patents. CPC has a strong tradition of

leadership in the quick disconnect market, and aggressively pursues and protects its proprietary information and intellectual property. In cases where it is practical and has a benefit to its customers, CPC has licensed its proprietary technology. Please contact CPC to discuss your unique needs.

**CPC TRADEMARK STATEMENT:** AseptiQuik®, BottleQuik®, BreakAway®, ChemQuik®, DrumQuik®, FitQuik®, IdentiQuik®, Nu-Seal®, SnapQuik®, Steam-Thru®, Softube® are registered trademarks with the U.S. Patent & Trademark Office. All other trademarks or service marks are property of their respective owners. **WARNING:** Due to the wide variety of possible fluid media and operating conditions, unintended consequences may result from the use of this product, all of which are beyond the control of CPC. It is the user's responsibility to carefully determine and test for compatibility for use with their application. All such risks shall be assumed by the buyer.

**WARNING:** Due to the wide variety of possible fluid media and operating conditions, unintended consequences may result from the use of this product, all of which are beyond the control of CPC. It is the user's responsibility to carefully determine and test for compatibility for use with their application. All such risks shall be assumed by the buyer.