

John Guest[®]

Drinks Dispense And Pure Water
Super Speedfit *Fittings, Valves and Tubing*



INTRODUCING

POLARCLEAN[®]

TUBE IN TUBE TECHNOLOGY

April 2016

The John Guest Group has a long established reputation as a world leading manufacturer of push-fit fittings, tube and other fluid control products. A reputation built on producing consistently high quality products with an ongoing commitment to value engineering and product development.



Quality Manufacture

A commitment to quality is at the heart of the John Guest philosophy.

The strictest control is maintained by virtue of the fact that design and manufacture is carried out in modern purpose built manufacturing centres in West London and at Maidenhead in Berkshire.

Maintaining control over the whole process from initial tool design and tool making through to final assembly and testing ensuring that only products of the highest quality are produced.

The company believe it is this commitment to quality that has led to it receiving prestigious awards from many of the world's leading testing and approvals organisations.

John Guest is a preferred supplier to many international companies.

John Guest offer the widest range of push-fit fittings, tube and other fluid control products for drinks dispense and pure water applications.

The world's first food quality push in fitting, the John Guest range is now over 800 items strong and provides the quickest and most effective of installations. Pushing the tube into the fitting is all that is needed to produce an instant but permanent leakproof connection.

The fittings are just as easy to disconnect and re use without the need for replacement parts.

The products in this catalogue are produced in FDA compliant materials making them especially suitable for potable liquids. Selected items can also be used for inert gases such as CO².



FAST INSTALLATION TIME 'RIGHT FIRST TIME EVERY TIME'

SUITABLE FOR SOFT METAL OR PLASTIC TUBES

NO TOOLS NEEDED

QUICK DISCONNECTION

RE-USABLE

SUPERIOR FLOW CHARACTERISTICS

Accepted by almost all the world's beer and beverage producers and by the manufacturers of drinks dispense equipment, John Guest products have quality and performance approvals from leading testing and acceptance authorities.



FM01977



Contents

	How to make a connection	05
	Typical Bar Installation	06
	Technical Specification	36

Inch Size Fittings

PI Fittings	Grey acetal for liquids and inert gases.	07 - 12
Polarclean Fittings	Tube in tube coaxial fittings for draught beer dispense systems.	13 - 14
CI Fittings	White acetal for pure water and other potable liquids.	15 - 16
PP Fittings	White polypropylene for pure water and a wide range of applications.	17 - 18
Superseal Fittings	Grey acetal for use with stainless steel tube.	19 - 20
MI Fittings	Brass fittings for beverage dispense applications.	21

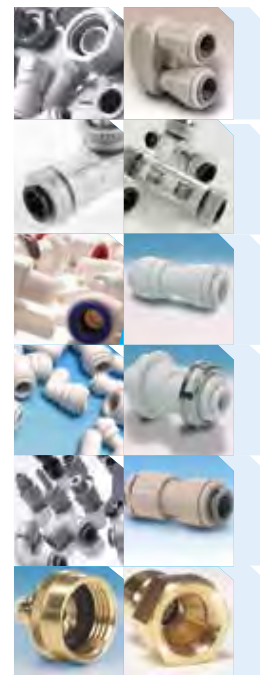

Metric to Imperial Adaptors

Metric to Imperial Adaptors	Converts metric sizes to inch and inch sizes to metric.	21
------------------------------------	---	-----------



Metric Size Fittings

CM Fittings	For drinks and other potable liquids.	22
PM Fittings	Black acetal for liquids and inert gases	23 - 26
PPM Fittings	White polypropylene for pure water and a wide range of applications	28



Valves, LLDPE Tube and Accessories

Angle Stop Valves and Elbow Stop Valves	White and Grey Acetal	28
Shut Off Valves	White polypropylene and grey acetal	29 - 30
Check Valves & Service Valves	Single and Double Check Valves and Service Valves	31 - 32
LLDPE Tube	Inch and metric sizes in 8 colours	33 - 34
Accessories	From Collet Covers to Tube Cutters	35



How Super Speedfit Works

To make a connection, the tube is simply pushed in by hand; the unique patented John Guest collet locking system then holds the tube firmly in place without deforming it or restricting flow.

Materials of construction

Super Speedfit fittings are made up of three components:

Bodies are produced in an acetal copolymer or polypropylene.

'O' rings are Nitrile rubber or EPDM.

Collets are produced in acetal copolymer or polypropylene with stainless steel teeth.



Grips before it seals

The Collet (gripper) has stainless steel teeth which hold the tube firmly in position while the 'O' ring provides a permanent leakproof seal.

How to make a connection

Cut the tube square



Cut the tube square and remove burrs and sharp edges. Ensure the outside diameter is free of score marks. For soft or thin walled tube we recommend the use of a tube insert.

Push up to tube stop



Push the tube into the fitting, to the tube stop.

Pull to check secure



Pull on the tube to check it is secure. Test the system before use.

To disconnect

Push in collet and remove tube



To disconnect, ensure the system is depressurized, push the collet square against the fitting. With the collet held in this position the tube can be removed.

Typical Bar Installation

Super Speedfit push-in fittings have been designed for a wide range of industrial applications. They provide a fast and secure way of connecting tubes and offer considerable advantages over conventional fittings.

Complex tubing systems can be assembled more rapidly than with traditional methods and because Super Speedfit fittings are easy to disconnect, fault finding and maintenance become a much easier operation.

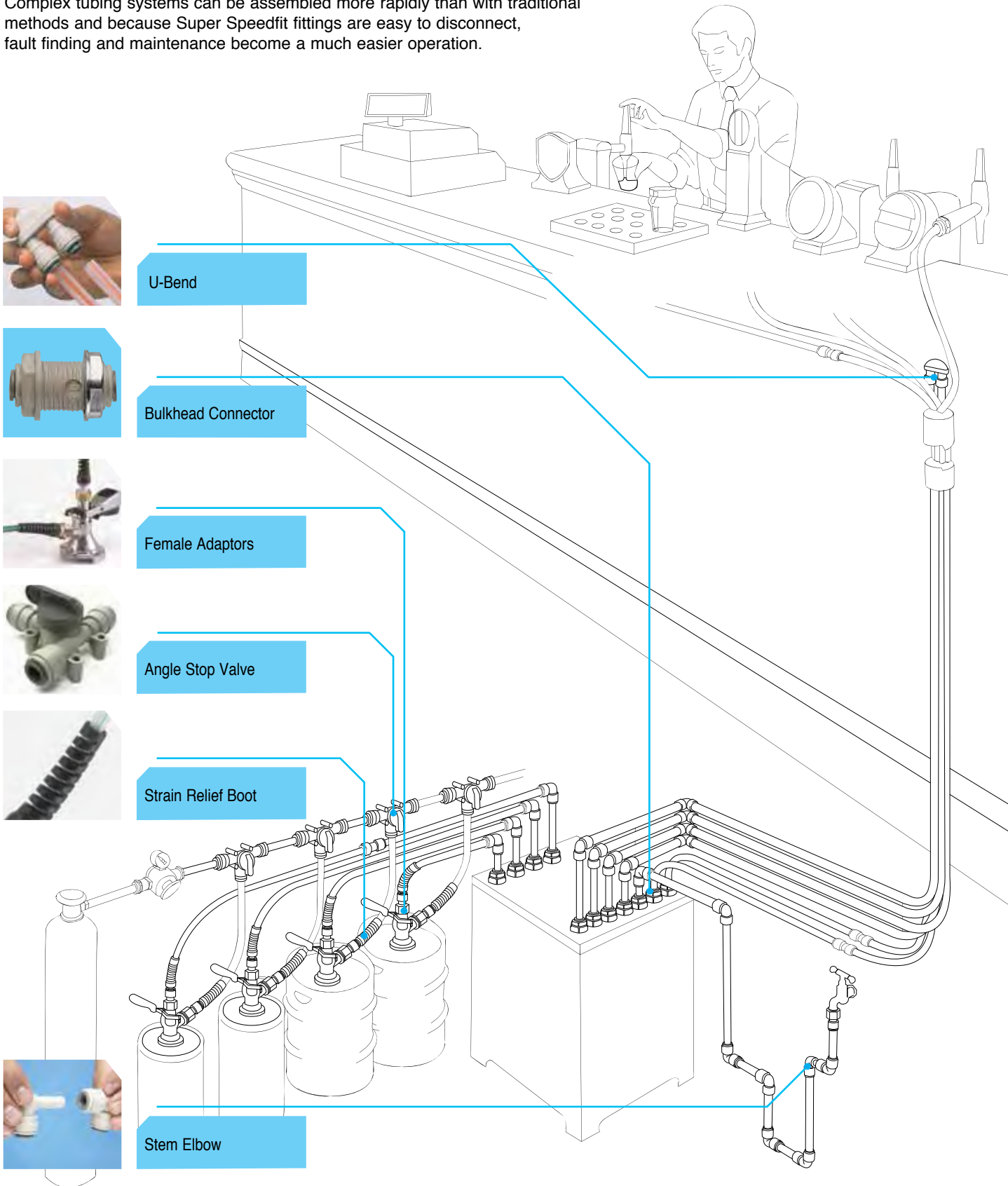

Grey Acetal Fittings

PI fittings offered in sizes 5/32" to 5/8" are manufactured in grey acetal copolymer, making them especially suitable for applications involving foodstuffs and potable liquids. They are however equally suitable for air and inert gases and can be used on N²/CO² (installed in accordance with The British Beer and Pub Association Code of Practice) mixed gas dispense lines and in pneumatic applications and vacuum.

Technical information shown on page 36.



*for liquids
& inert gases*

STRAIGHT ADAPTOR BSP T Thread



PART NO.	TUBE OD	THREAD BSPT
PM010401S	5/32	x 1/8
PM010402S	5/32	x 1/4
PI010601S	3/16	x 1/8
PI010602S	3/16	x 1/4
PI010801S	1/4	x 1/8
PI010802S	1/4	x 1/4
PM010801S	5/16	x 1/8
PM010802S	5/16	x 1/4
PM010803S	5/16	x 3/8
PI011202S	3/8	x 1/4
PI011203S	3/8	x 3/8
PI011603S	1/2	x 3/8
PI011604S	1/2	x 1/2

STRAIGHT ADAPTOR BSP Thread



PART NO.	TUBE OD	THREAD BSP
NCPI011211S	3/8	x 1/8
NCPI011212S	3/8	x 1/4

3/8" x 1/4" has special large seal for use with chamfered face ports.

No thread seal on 3/8" x 1/8".

STRAIGHT ADAPTOR British Nipple Type



PART NO.	TUBE OD	THREAD BSW
PI0106E5S	3/16	x 1/2 - 24
PI0108E5S	1/4	x 1/2 - 24
PM0108E5S	5/16	x 1/2 - 24
PM0108E6S	5/16	x 9/16 - 24
PI0112E5S	3/8	x 1/2 - 24
PI0112E6S	3/8	x 9/16 - 24

STRAIGHT ADAPTOR BSP Thread



PART NO.	TUBE OD	THREAD BSP
PI010812S	1/4	x 1/4
PI011212S	3/8	x 1/4
PI011213S	3/8	x 3/8
PI011613S	1/2	x 3/8

For use with spot face ports.

STRAIGHT ADAPTOR NPTF Thread



PART NO.	TUBE OD	THREAD NPTF
PM010421S	5/32	x 1/8
PM010422S	5/32	x 1/4
PI010621S	3/16	x 1/8
PI010821S	1/4	x 1/8
PI010822S	1/4	x 1/4
PI010823S	1/4	x 3/8
PM010821S	5/16	x 1/8
PM010822S	5/16	x 1/4
PM010823S	5/16	x 3/8
PI011221S	3/8	x 1/8
PI011222S	3/8	x 1/4
PI011223S	3/8	x 3/8
PI011224S	3/8	x 1/2
PI011623S	1/2	x 3/8
PI011624S	1/2	x 1/2
PI012026S	5/8	x 3/4

STRAIGHT ADAPTOR MFL Thread



PART NO.	TUBE OD	THREAD MFL
PI0108F4S	1/4	x 1/4
PI0112F4S	3/8	x 1/4
PI0112F5S	3/8	x 5/16
PI0112F6S	3/8	x 3/8
PI0112F8S	3/8	x 1/2
PI0116F8S	1/2	x 1/2
PM0108C5S	5/16	x 1/2 - 16 UN
PI0112C5S	3/8	x 1/2 - 16 UN

OUTLET ADAPTOR Parallel Thread



PART NO.	TUBE OD	THREAD BSP
NC128/112	3/8	x 1/4

EQUAL ELBOW



PART NO.	TUBE OD	
PM0304S	5/32	
PI0306S	3/16	
PI0308S	1/4	
PM0308S	5/16	
PI0312S	3/8	
PI0316S	1/2	
PI0308S-B	1/4	Blue Collet

RIGID ELBOW NPTF Thread



PART NO.	TUBE OD	THREAD NPTF
PI480821S	1/4	x 1/8
PI480822S	1/4	x 1/4
PI480823S	1/4	x 3/8
PI481022S	5/16	x 1/4
PI481023S	5/16	x 3/8
PI481222S	3/8	x 1/4
PI481223S	3/8	x 3/8
PI482024S	5/8	x 1/2

EQUAL STRAIGHT CONNECTOR



PART NO.	TUBE OD
PM0404S	5/32
PI0406S	3/16
PI0408S	1/4
PM0408S	5/16
PI0412S	3/8
PI0416S	1/2

REDUCING ELBOW



PART NO.	TUBE OD	TUBE OD
PM210804S	5/16	- 5/32
PI211006S	5/16	- 3/16
PI211008S	5/16	- 1/4
PI211206S	3/8	- 3/16
PI211208S	3/8	- 1/4
PI211210S	3/8	- 5/16
PI211610S	1/2	- 5/16
PI211612S	1/2	- 3/8

EQUAL TEE



PART NO.	TUBE OD
PM0204S	5/32
PI0206S	3/16
PI0208S	1/4
PM0208S	5/16
PI0212S	3/8
PI0216S	1/2

REDUCING STRAIGHT CONNECTOR



PART NO.	TUBE OD	TUBE OD
PI200806S	1/4	- 3/16
PM200804S	5/16	- 5/32
PI201006S	5/16	- 3/16
PI201008S	5/16	- 1/4
PI201206S	3/8	- 3/16
PI201208S	3/8	- 1/4
PI201210S	3/8	- 5/16
PI201608S	1/2	- 1/4
PI201610S	1/2	- 5/16
PI201612S	1/2	- 3/8

STEM ELBOW



PART NO.	STEM OD	TUBE OD
PM220404S	5/32	- 5/32
PI220606S	3/16	- 3/16
PI220808S	1/4	- 1/4
PM220808S	5/16	- 5/16
PI221206S	3/8	- 3/16
PI221208S	3/8	- 1/4
PI221210S	3/8	- 5/16
PI221212S	3/8	- 3/8
PI221616S	1/2	- 1/2

REDUCING TEE



PART NO.	TUBE OD ENDS	TUBE OD BRANCH
PI301208S	3/8	- 1/4
PI301612S	1/2	- 3/8



Accessories for PI Fittings are shown on page 33.

John Guest®

Adaptability

SWIVEL ELBOW

BSPT Thread



PART NO.	TUBE OD	THREAD BSPT
PI090601S	3/16	x 1/8
PI090801S	1/4	x 1/8
PI090802S	1/4	x 1/4
PM090801S	5/16	x 1/8
PM090802S	5/16	x 1/4
PM090803S	5/16	x 3/8
PI091202S	3/8	x 1/4
PI091203S	3/8	x 3/8
PI091603S	1/2	x 3/8
PI091604S	1/2	x 1/2

SWIVEL BRANCH TEE

BSPT Thread



PART NO.	TUBE OD	THREAD BSPT
PI100601S	3/16	x 1/8
PI100801S	1/4	x 1/8
PI100802S	1/4	x 1/4
PM100801S	5/16	x 1/8
PM100802S	5/16	x 1/4
PM100803S	5/16	x 3/8
PI101202S	3/8	x 1/4
PI101203S	3/8	x 3/8
PI101603S	1/2	x 3/8
PI101604S	1/2	x 1/2

SWIVEL MALE RUN TEE

BSPT Thread



PART NO.	TUBE OD	THREAD BSPT
PI110601S	3/16	x 1/8
PI110801S	1/4	x 1/8
PI110802S	1/4	x 1/4
PM110801S	5/16	x 1/8
PM110802S	5/16	x 1/4
PM110803S	5/16	x 3/8
PI111202S	3/8	x 1/4
PI111203S	3/8	x 3/8
PI111603S	1/2	x 3/8
PI111604S	1/2	x 1/2

SWIVEL ELBOW

NPTF Thread



PART NO.	TUBE OD	THREAD NPTF
PM090421S	5/32	x 1/8
PM090422S	5/32	x 1/4
PI090621S	3/16	x 1/8
PI090821S	1/4	x 1/8
PI090822S	1/4	x 1/4
PM090821S	5/16	x 1/8
PM090822S	5/16	x 1/4
PM090823S	5/16	x 3/8
PI091222S	3/8	x 1/4
PI091223S	3/8	x 3/8
PI091623S	1/2	x 3/8
PI091624S	1/2	x 1/2

SWIVEL BRANCH TEE

NPTF Thread



PART NO.	TUBE OD	THREAD NPTF
PM100421S	5/32	x 1/8
PM100422S	5/32	x 1/4
PI100621S	3/16	x 1/8
PI100821S	1/4	x 1/8
PI100822S	1/4	x 1/4
PM100821S	5/16	x 1/8
PM100822S	5/16	x 1/4
PM100823S	5/16	x 3/8
PI101222S	3/8	x 1/4
PI101223S	3/8	x 3/8
PI101623S	1/2	x 3/8
PI101624S	1/2	x 1/2

SWIVEL MALE RUN TEE

NPTF Thread



PART NO.	TUBE OD	THREAD NPTF
PM110421S	5/32	x 1/8*
PM110422S	5/32	x 1/4*
PI110621S	3/16	x 1/8
PI110821S	1/4	x 1/8
PI110822S	1/4	x 1/4
PM110821S	5/16	x 1/8*
PM110822S	5/16	x 1/4
PM110823S	5/16	x 3/8*
PI111222S	3/8	x 1/4
PI111223S	3/8	x 3/8
PI111623S	1/2	x 3/8*
PI111624S	1/2	x 1/2*

* Obtained by using an Equal Tee shown on page 3 and a Stem Adaptor, shown on page 11.

John Guest Adaptability

Standard **Super Speedfit** products can be coupled together to form integral new fittings.

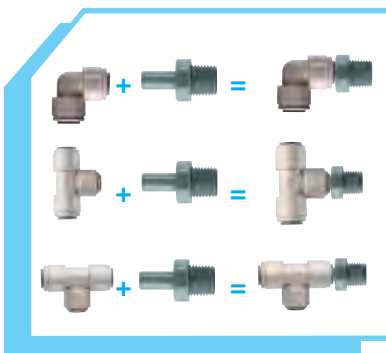

STRAIN RELIEF BOOT



PART NO.	SIZE
NC2447	3/8"
NC2448	1/2"

To suit most 3/8" or 1/2" fittings.

The Strain Relief Boot has been developed to reduce the potential strain on the tubing. The Boot limits the bend radius of the tube, preventing it from kinking.



Female Adaptors

4 Tube Sizes

5 Thread Forms

10 Thread Sizes

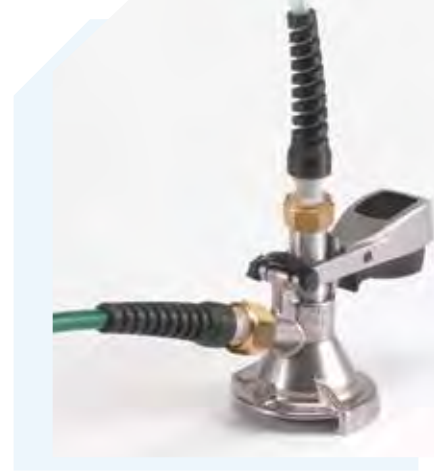

FEMALE ADAPTOR BSP Thread - Flat End

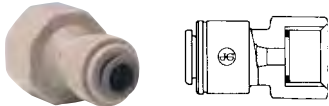

PART NO.	TUBE OD	THREAD BSP
PI451014FS	5/16	x 1/2
PI451015FS	5/16	x 5/8
PI451213S	3/8	x 3/8
PI451214FS	3/8	x 1/2
PI451215FS	3/8	x 5/8
PI451613S	1/2	x 3/8
PI451615FS	1/2	x 5/8

FEMALE ADAPTOR British Whitworth Thread

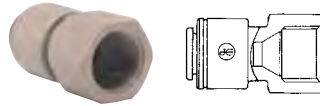

PART NO.	TUBE OD	THREAD BSW
PM4508E5S	5/16	x 1/2 - 24
PI4512E6S	3/8	x 9/16 - 24

TAP ADAPTOR BSP Thread



PART NO.	TUBE OD	THREAD BSP
CI320814S	1/4	x 1/2
CI320816S	1/4	x 3/4
CI321214S	3/8	x 1/2
CI321216S	3/8	x 3/4

Not suitable for air

FEMALE ADAPTOR UNS Thread



PART NO.	TUBE OD	THREAD UNS
PM4508C5S	5/16	x 1/2 - 16
PI4512C5S	3/8	x 1/2 - 16
PI4516C5S	1/2	x 1/2 - 16

TAP ADAPTOR BSP Thread - Flat End



PART NO.	TUBE OD	THREAD BSP
CI320816FS	1/4	x 3/4
CI321216FS	3/8	x 3/4

Not suitable for air

FEMALE ADAPTOR BSP Thread - Cone End



PART NO.	TUBE OD	THREAD BSP
PI451014CS	5/16	x 1/2
PI451015CS	5/16	x 5/8
PI451214CS	3/8	x 1/2
PI451215CS	3/8	x 5/8
PI451614CS	1/2	x 1/2
PI451615CS	1/2	x 5/8
PI451616CS	1/2	x 3/4

FEMALE ADAPTOR NPTF Thread

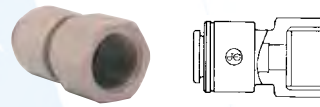

PART NO.	TUBE OD	THREAD NPTF
PI450822S	1/4	x 1/4
PI451222S	3/8	x 1/4

TAP ADAPTOR UNS Thread



PART NO.	TUBE OD	THREAD UNS
CI3208U7S	1/4	x 7/16 - 24
CI3210U7S	5/16	x 7/16 - 24
CI3212U7S	3/8	x 7/16 - 24

Not suitable for air

FEMALE ADAPTOR BSP Thread - Small Cone End

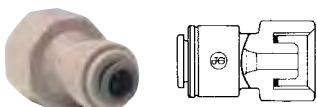

PART NO	TUBE OD	THREAD BSP
NCP1451214CS	3/8	x 1/2

Typically used on beer outlet/gas inlet of keg couplers. Cone supports 'Top Hat' type Duck Bill Valve.

FEMALE ADAPTOR FFL Thread

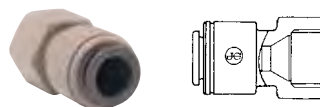

PART NO.	TUBE OD	THREAD FFL
PM4508F4S	5/16	x 1/4
PI4512F4S	3/8	x 1/4
PI4512F6S	3/8	x 3/8

1/4 (FFL) corresponds to a 7/16 UNF
3/8 (FFL) corresponds to a 5/8 UNF

KEG BEER OUTLET ADAPTOR



PART NO.	TUBE OD	THREAD BSP
PI561214CS	3/8	x 1/2

KEG GAS INLET ADAPTOR



PART NO.	TUBE OD	THREAD BSP
PI561214CS-NRV	3/8	x 1/2

THREE WAY DIVIDER



PART NO.	TUBE OD INLET	TUBE OD OUTLET
PI491612S	1/2	3/8
PI491616S	1/2	1/2

THREE WAY DIVIDER



PART NO.	TUBE OD INLET	TUBE OD OUTLET
PI491212S-R	3/8"	3/8"

TWO-WAY DIVIDER



PART NO.	TUBE OD
PI2308S	1/4
PM2308S	5/16
PI2312S	3/8
PI2316S	1/2

UNEQUAL TWO-WAY DIVIDER

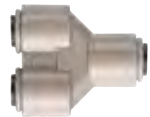

PART NO.	TUBE OD INLET	TUBE OD OUTLET
PI241210S	3/8	5/16

BULKHEAD CONNECTOR



PART NO.	TUBE OD
PM1204S	5/32
PI1206S	3/16
PI1208S	1/4
PM1208S	5/16
PI1212S	3/8
PI1216S	1/2

REDUCING BULKHEAD CONNECTOR



PART NO.	TUBE OD	TUBE OD
PI121208S	3/8	1/4
NC2429	1/4"	6mm

STEM ADAPTOR

BSPT Thread



PART NO.	STEM OD	THREAD BSPT
PI050601S	3/16	x 1/8
PI050801S	1/4	x 1/8
PI050802S	1/4	x 1/4
PM050801S	5/16	x 1/8
PM050802S	5/16	x 1/4
PM050803S	5/16	x 3/8
PI051202S	3/8	x 1/4
PI051203S	3/8	x 3/8
PI051603S	1/2	x 3/8
PI051604S	1/2	x 1/2

STEM ADAPTOR

BSP Thread



PART NO.	STEM OD	THREAD BSP
PM050812S	5/16	x 1/4
PI051212S	3/8	x 1/4
PI051213S	3/8	x 3/8

STEM ADAPTOR

NPTF Thread



PART NO.	STEM OD	THREAD NPTF
PM050421S	5/32	x 1/8
PM050422S	5/32	x 1/4
PI050621S	3/16	x 1/8
PI050821S	1/4	x 1/8
PI050822S	1/4	x 1/4
PI050823S	1/4	x 3/8
PM050821S	5/16	x 1/8
PM050822S	5/16	x 1/4
PM050823S	5/16	x 3/8
PI051222S	3/8	x 1/4
PI051223S	3/8	x 3/8
PI051623S	1/2	x 3/8
PI051624S	1/2	x 1/2

STEM ADAPTOR

British Nipple Type



PART NO.	STEM OD	THREAD BSW
PM0508E6S	5/16	x9/16 - 24
PI0512E5S	3/8	x 1/2 - 24
PI0512E6S	3/8	x 9/16 - 24

TUBE TO HOSE STEM



PART NO.	STEM OD	HOSE ID
PI250806S	1/4	- 3/16
PI250808S	1/4	- 1/4
PI250810S	1/4	- 5/16
PI251006S	5/16	- 3/16
PI251008S	5/16	- 1/4
PM250808S	5/16	- 5/16
PI251012S	5/16	- 3/8
PI251208S	3/8	- 1/4
PI251210S	3/8	- 5/16
PI251212S	3/8	- 3/8
PI251216S	3/8	- 1/2
PI251612S	1/2	- 3/8
PI251616S	1/2	- 1/2

TUBE TO HOSE STEM

Long Version



PART NO.	STEM OD	HOSE ID
PI251012SL	5/16	- 3/8
PI251212SL	3/8	- 3/8

TUBE TO HOSE ELBOW



PART NO.	STEM OD	HOSE ID
PI290808S	1/4	- 1/4
PI290810S	1/4	- 5/16
PI291008S	5/16	- 1/4
PM290808S	5/16	- 5/16
PI291208S	3/8	- 1/4
PI291210S	3/8	- 5/16

Adaptors to convert to Metric sizes are shown on page 19.



ENLARGER



PART NO.	TUBE OD	STEM OD
PI131012S	3/8	5/16
PI131216S	1/2	3/8

REDUCER



PART NO.	STEM OD	TUBE OD
PI060605S	3/16	5/32
PI061006S	5/16	3/16
PI061008S	5/16	1/4
PI061206S	3/8	3/16
PI061208S	3/8	1/4
PI061210S	3/8	5/16
PI061610S	1/2	5/16
PI061612S	1/2	3/8

CROSS



PART NO.	TUBE OD
PI4712S	3/8

DISPENSING VALVE ELBOW



PART NO.	TUBE OD
NC356-02	3/8

DISPENSING VALVE STEM



PART NO.	STEM OD
NC730-02	3/8

OFFSET CONNECTOR



PART NO.	TUBE OD	TUBE OD
NC641	1/2	5/16

U-BEND



PART NO.	TUBE OD
PIUB12S	3/8
PIUB16S	1/2



PLUG



PART NO.	STEM OD
PM0804S	5/32
PI0806S	3/16
PI0808S	1/4
PM0808S	5/16
PI0812S	3/8
PI0816S	1/2

END STOP



PART NO.	TUBE OD
PI4608S	1/4
PI4612S	3/8

COOLING MANIFOLD



PART NO.	TUBE SIZE ENDS	TUBE SIZE BRANCHES
NC2183	15mm	3/8"

Intended for use on a 15mm Water Recirculation System.

A 4mm restriction between the two 15mm ports directs a proportion of recirculation water around a 3/8" looped spur.

Performance characteristics are dependent on a number of variables so it is recommended that suitability is assessed against the customer's own criteria.

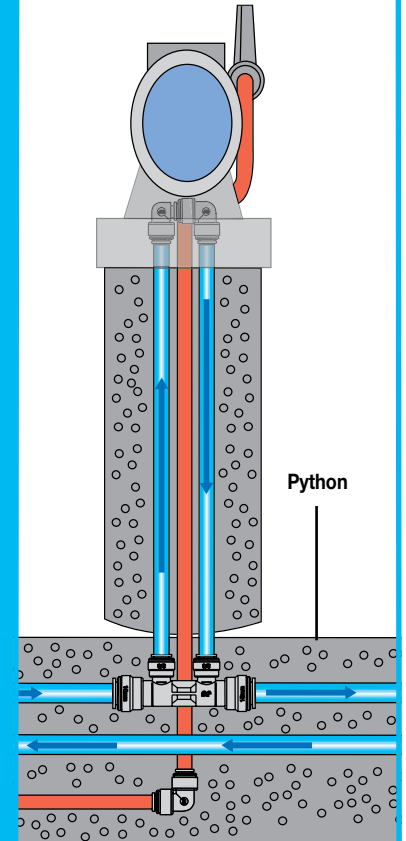

Accessories for PI Fittings are shown on page 33.





TUBE IN TUBE TECHNOLOGY

The John Guest range of tube-in-tube technology has recently been extended to further satisfy the requirements of a draught beer dispense system, from beer barrel to tap. A tube-in-tube system can help maintain critical temperature conditioning of beer or beverage in the pipeline by enabling each product tube to be fully enveloped by recirculating coolant, usually either water or a water glycol blend, over the entire pipeline length. Subject to system configuration, this may offer significant benefits to the retail outlet, brand owner and consumer when compared to a traditional draught dispense system or packaged product restriction.

System Benefits

- *Consistent temperature at pour - to brand specification / customer satisfaction*
- *Extra cold temperature capability without necessity of a coldroom or secondary cooling device & associated running / maintenance costs & space utilisation*
- *Microbiological activity is reduced at low temperature & product quality is less prone to microbial related complaints e.g. 'off flavours', beer fobbing, subject to an appropriate cleaning regime. Less waste means more revenue per barrel*
- *Genuine draught dispense where not previously a viable option*

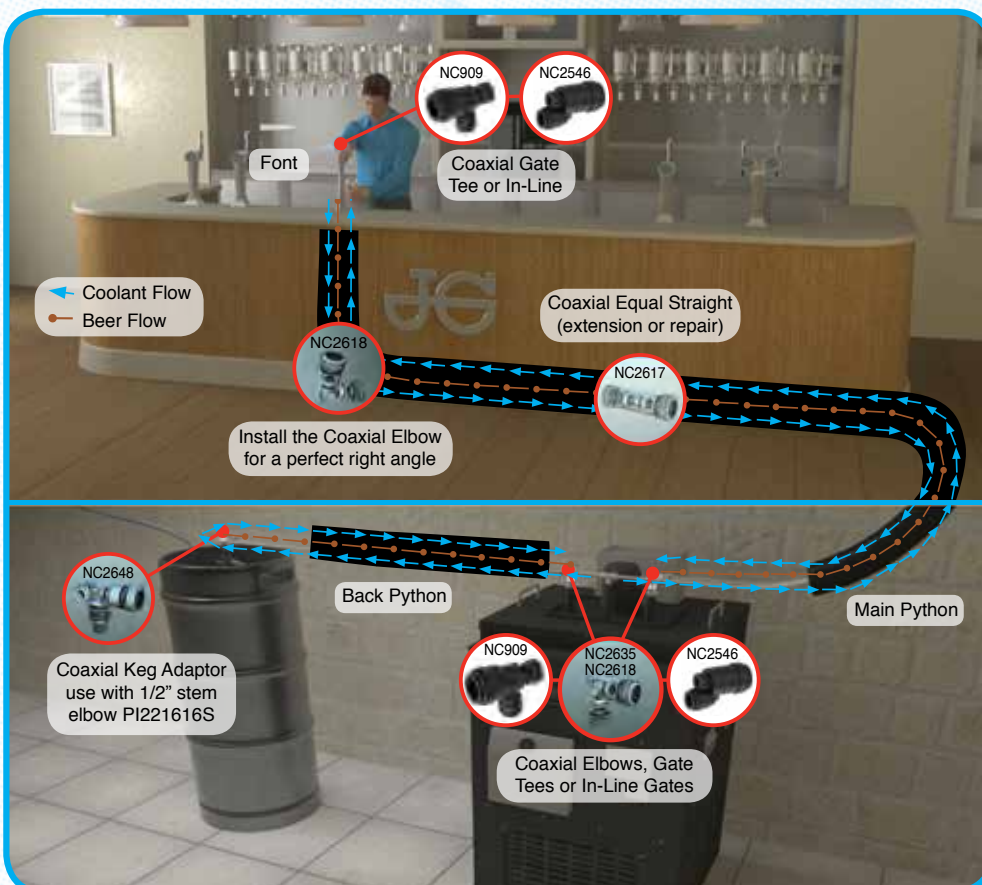

Working Pressures and Temperatures

Water 5 Bar at 30°C Max
 Minimum Temperature 1°C

TO MAKE A TUBE IN TUBE CONNECTION

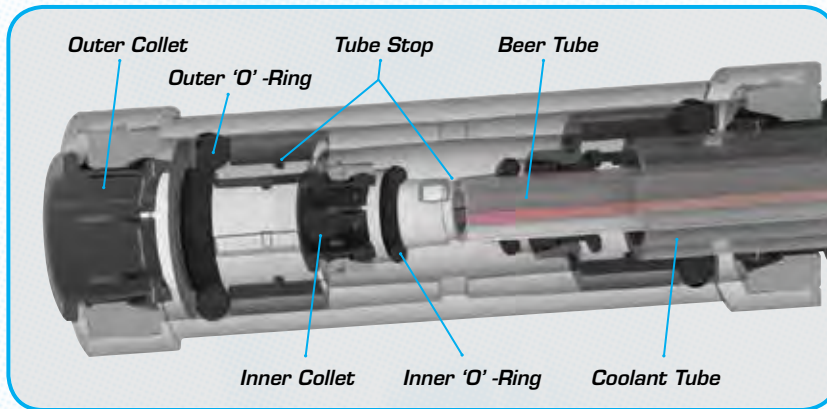

For transparent connectors:

1. Push beer tube up to tube stop. Visually confirm correct tube positioning and pull to check connection is secure.
2. Push the coolant tube up to the tube stop. Visually confirm correct tube positioning and pull to check connection is secure.
3. Connect beer supply and check for leakages.
4. Connect coolant supply and check for leakages.

TO DISCONNECT A TUBE IN TUBE CONNECTION



For transparent connectors:

1. Ensure both beer and coolant lines are depressurised. Push and hold the outer collet square against the face of the fitting whilst withdrawing the coolant tube.
2. Fit the Coaxial Collet Release Tool (NC2654) over the beer tube and slide into the Coaxial Connector until square against the inner collet. Depress the inner collet whilst withdrawing beer tube.
3. Remove Release Tool.

NOTE: For non-transparent coaxial connectors the beer tube passes through the connector without interruption.

NOTE: ALL 'OUTER' COAXIAL COOLANT TUBES ARE 18MM DIAMETER.

EQUAL STRAIGHT CONNECTOR



PART NO.	INNER TUBE OD
NC2617	3/8

EQUAL ELBOW CONNECTOR



PART NO.	INNER TUBE OD
NC2618	3/8

REDUCING ELBOW CONNECTOR



PART NO.	INNER TUBE OD	INNER TUBE OD (RED COLLET)
NC2635	3/8	x 8

COAXIAL KEG CONNECTOR



Typically used with PI221616S at side inlet.

PART NO.	INNER TUBE OD	SIDE INLET TUBE OD
NC2648	3/8	x 1/2

COAXIAL TEE CONNECTOR



PART NO.	INNER TUBE OD	BRANCH TUBE OD
NC909	3/8	x 3/8

PARALLEL CONNECTOR



PART NO.	INNER TUBE OD	BRANCH TUBE OD
NC2546	3/8	x 1/2

INTERNAL COLLET RELEASE TOOL



PART NO.
NC2654

White Acetal Fittings

CI inch size fittings are manufactured in white acetal. With a food grade EPDM 'O' ring, they have been developed for the water industry but are equally suitable for other potable liquids. They are also recommended for intermittent hot water applications.

Selected items are available with red or blue collets.

The CI Range is NOT suitable for compressed air and vacuum applications. For these situations we recommend the PI Range on pages 07 - 12.

Working Pressures and Temperatures

Water 10 BAR at 20°C

7 BAR at 65°C intermittent hot water

Other technical information is shown on page 36.



EQUAL STRAIGHT CONNECTOR



PART NO.	TUBE OD
CI0408W	1/4
CI0412W	3/8

STEM ELBOW



PART NO.	STEM OD	TUBE OD	
CI220808W	1/4	1/4	
CI221208W	3/8	1/4	
CI221212W	3/8	3/8	
CI220808WB	1/4	1/4	Blue Collet
CI221212WB	3/8	3/8	Blue Collet
CI220808WR	1/4	1/4	Red Collet
CI221212WR	3/8	3/8	Red Collet

STEM TEE



PART NO.	TUBE OD	TUBE OD	TUBE OD
CI580808W	1/4	1/4	1/4

STRAIGHT ADAPTOR NPTF Thread



PART NO.	TUBE OD	THREAD NPTF
CI010821W	1/4	x 1/8
CI010822W	1/4	x 1/4
CI010823W	1/4	x 3/8
CI011222W	3/8	x 1/4

RIGID ELBOW NPTF Thread



PART NO.	TUBE OD	THREAD NPTF	
CI480821W	1/4	x 1/8	
CI480822W	1/4	x 1/4	
CI480823W	1/4	x 3/8	
CI481222W	3/8	x 1/4	
CI480821WB	1/4	x 1/8	Blue Collet

BRANCH STEM TEE



PART NO.	TUBE OD	TUBE OD	TUBE OD
CI530808W	1/4	1/4	1/4

EQUAL ELBOW



PART NO.	TUBE OD	
CI0308W	1/4	
CI0312W	3/8	
CI0308WB	1/4	Blue Collet
CI0312WB	3/8	Blue Collet
CI0312WR	3/8	Red Collet

EQUAL TEE



PART NO.	TUBE OD	
CI0208W	1/4	
CI0212W	3/8	
CI0208WB	1/4	Blue Collet

BULKHEAD CONNECTOR



PART NO.	TUBE OD
CI1208W	1/4

FEMALE CONNECTOR BSP Thread



PART NO.	TUBE OD	THREAD BSP
CI450814FW	1/4	x 1/2

for pure water and potable liquids

pure water & potable liquids

FEMALE ADAPTOR NPTF Thread



PART NO.	TUBE OD	THREAD NPTF
CI451222W	3/8	x 1/4

TUBE TO HOSE ELBOW



PART NO.	STEM OD	HOSE ID
CI291208W	3/8	- 1/4

STEM ADAPTOR NPTF Thread



PART NO.	STEM OD	THREAD NPTF
CI050821W	1/4	x 1/8
CI050822W	1/4	x 1/4
CI051222W	3/8	x 1/4
CI051223W	3/8	x 3/8

TAP ADAPTOR



PART NO.	TUBE OD	THREAD UNS
CI3212U7FW	3/8	x 7/16

John Guest Adaptability

Standard *Super Speedfit* products can be coupled together to form integral new fittings.

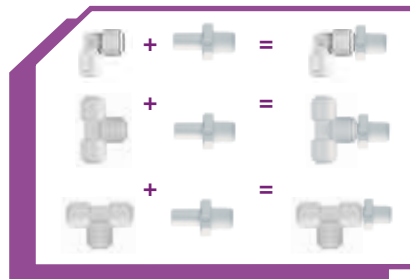

REDUCER



PART NO.	STEM OD	TUBE OD
CI061208W	3/8	- 1/4

BARB CONNECTOR Superseal X Barb



PART NO.	SUPERSEAL OD	TUBE ID
CI270808W	1/4	- 1/4

Accessories for CI Fittings are shown on page 33.



Polypropylene Fittings

The PP Range of inch size push-in fittings is produced in white polypropylene and fitted with EPDM seals.

Polypropylene has the advantage of being more chemically resistant than acetal.

Working Pressures and Temperatures

Water 10 Bar at 20°C
4 Bar at 60°C

Minimum Temperature 1°C

Other technical information is shown on page 36.



STRAIGHT ADAPTOR NPTF Thread



PART NO.	TUBE OD	THREAD NPTF
PP010821W	1/4	- 1/8
PP010822W	1/4	- 1/4
PP010823W	1/4	- 3/8
PP010824W	1/4	- 1/2
PP011222W	3/8	- 1/4
PP011223W	3/8	- 3/8
PP011224W	3/8	- 1/2
PP011623W	1/2	- 3/8
PP011624W	1/2	- 1/2

NEW

EQUAL TEE



PART NO.	TUBE OD
PP0208W	1/4
PPM0208W	5/16
PP0212W	3/8
PP0216W	1/2
PP0208W-B	1/4 Blue Collet

REDUCING ELBOW



PART NO.	TUBE OD	TUBE OD
PP211008W	5/16	- 1/4
PP211208W	3/8	- 1/4
PP211612W	1/2	- 3/8

STEM ELBOW



PART NO.	STEM OD	TUBE OD
PP220808W	1/4	- 1/4
PPM220808W	5/16	- 5/16
PP221208W	3/8	- 1/4
PP221212W	3/8	- 3/8
PP221616W	1/2	- 1/2
PP221212W-B	3/8	- 3/8 Blue Collet

EQUAL STRAIGHT CONNECTOR



PART NO.	TUBE OD
PP0408W	1/4
PPM0408W	5/16
PP0412W	3/8
PP0416W	1/2

REDUCING TEE



PART NO.	TUBE OD END	TUBE OD END	TUBE OD BRANCH
PP30080812W	1/4	1/4	3/8
PP30120812W	3/8	1/4	3/8
PP30121208W	3/8	3/8	1/4
PP301612W	1/2	1/2	3/8

STEM TEE



PART NO.	TUBE OD END	TUBE OD END	TUBE OD BRANCH
PP531212W	3/8	3/8	3/8

RIGID ELBOW NPTF Thread



PART NO.	TUBE OD	THREAD NPTF
PP480821W	1/4	x 1/8
PP480822W	1/4	x 1/4
PP480823W	1/4	x 3/8
PP481222W	3/8	x 1/4
PP481223W	3/8	x 3/8
PP481623W	1/2	x 3/8

NEW

REDUCING STRAIGHT CONNECTOR



PART NO.	TUBE OD	TUBE OD
PP201208W	3/8	- 1/4
PP201612W	1/2	- 3/8

EQUAL ELBOW



PART NO.	TUBE OD
PP0308W	1/4
PPM0308W	5/16
PP0312W	3/8
PP0316W	1/2
PP0308W-B	1/4 Blue Collet

BULKHEAD CONNECTOR



PART NO.	TUBE OD
PP1208W	1/4
PP1212W	3/8
PP1216W	1/2

Inch size - white polypropylene for pure water and a wide range of applications

REDUCING BULKHEAD CONNECTOR



PART NO.	TUBE OD	TUBE OD
PP121208W	3/8	1/4

REDUCER



PART NO.	STEM OD	TUBE OD
PP061208W	3/8	1/4
PP061210W	3/8	5/16
PP061612W	1/2	3/8
PP062008W	5/8	1/4
PP062012W	5/8	3/8
PP062016W	5/8	1/2

UNEQUAL DIVIDER



PART NO.	TUBE OD	TUBE OD
PP241208W	1/4	3/8

FEMALE ADAPTOR NPTF Thread



PART NO.	TUBE OD	THREAD NPTF
PP450821W	1/4	x 1/8
PP450822W	1/4	x 1/4
PP451222W	3/8	x 1/4
PP451223W	3/8	x 3/8

THREE WAY DIVIDER



PART NO.	TUBE OD INLET	TUBE OD OUTLET
PP491208W*	3/8	1/4

DIVIDER



PART NO.	TUBE OD
PP2312W	3/8

TAP ADAPTOR UNS Thread



PART NO.	TUBE OD	THREAD UNS
PP3208U7W	1/4	x 7/16 - 24
PP3212U7W	3/8	x 7/16 - 24

PLUG



PART NO.	STEM OD
PP0808W	1/4
PPM0808W	5/16
PP0812W	3/8
PP0816W	1/2

TWO WAY DIVIDER



Push-fit fitting with improved UV resistance and suitable for a wide variety of applications.

PART NO.	TUBE OD
PP2308E	1/4

STEM ADAPTOR NPTF Thread



PART NO.	STEM OD	THREAD NPTF
PP050821W	1/4	x 1/8
PP050822W	1/4	x 1/4
PP051222W	3/8	x 1/4
PP051223W	3/8	x 3/8
PP051623W	1/2	x 3/8
PP051624W	1/2	x 1/2

TUBE TO HOSE STEM



PART NO.	STEM OD	HOSE ID
PP251212W	3/8	3/8
PP251216W	3/8	1/2
PP251612W	1/2	3/8
PP251616W	1/2	1/2

END STOP



PART NO.	TUBE OD
PP4608W	1/4

Superseal Fittings

For use with Stainless Steel

Superseal is a special fitting designed to provide extra grip on hard steel, stainless steel and other polished metal tubing.

The Superseal design features a collet with integrally moulded stainless steel teeth similar to the standard Super Speedfit design, but incorporating an additional hand-operated nut and wedge shaped plastic washer to apply extra pressure to the collet and the double 'O' ring seals. This ensures that the collet teeth bite thoroughly into the tube to provide grip while at the same time, compressing the 'O' rings to further enhance sealing.

Like other John Guest fittings Superseal is suitable for potable liquids and other food quality applications.

Technical information shown on page 36.



STRAIGHT ADAPTOR

BSPT Thread



PART NO.	SUPERSEAL OD	THREAD
SM010802S	5/16	x 1/4 BSPT

STRAIGHT CONNECTOR

Superseal X Superseal



PART NO.	SUPERSEAL OD
SM410808E	5/16

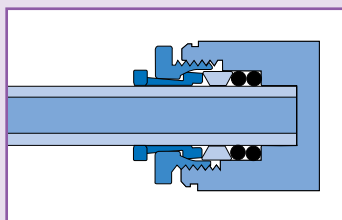
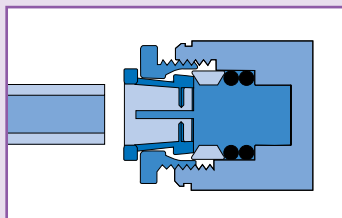

STRAIGHT ADAPTOR

BSP Thread



PART NO.	SUPERSEAL OD	THREAD
SM010812S	5/16	x 1/4 BSP

STRAIGHT CONNECTOR

Superseal X Speedfit



PART NO.	SUPERSEAL OD	SPEEDFIT OD
SM040808S	5/16	- 5/16
SI041012S	5/16	- 3/8
SI041016S	5/16	- 1/2
SI041210S	3/8	- 5/16
SI041212S	3/8	- 3/8
SI041216S	3/8	- 1/2

STRAIGHT ADAPTOR

MFL Thread



PART NO.	SUPERSEAL OD	THREAD
SM0108F4S	5/16	x 1/4 MFL

STRAIGHT ADAPTOR

Whitworth Thread



PART NO.	SUPERSEAL OD	THREAD
SI0112E6S	3/8	x 9/16-24 BSW

METRIC SIZE

STRAIGHT CONNECTOR

SUPERSEAL X SPEEDFIT



PART NO.	SUPERSEAL OD	SPEEDFIT OD
SM040608E	6mm	- 8mm



for use with stainless steel tube

ELBOW

Superseal X Superseal



PART NO.	SUPERSEAL OD	SUPERSEAL OD
SM400808S	5/16	5/16
SI401210S	3/8	5/16
SI401212S	3/8	3/8

BARB CONNECTOR



PART NO.	SUPERSEAL OD	TUBE ID
SI270808S	1/4	1/4
SI271008S	5/16	1/4
SI271208S	3/8	1/4

ELBOW

Superseal X Speedfit



PART NO.	SUPERSEAL OD	SPEEDFIT OD
SI030812S	1/4	3/8
SM030808S	5/16	5/16
SI031012S	5/16	3/8
SI031210S	3/8	5/16
SI031212S	3/8	3/8

BULKHEAD CONNECTOR

Superseal X
Speedfit



PART NO.	SUPERSEAL OD	SPEEDFIT OD
SM120808S	5/16	5/16

FLOW BEND CONNECTOR

Superseal X
Speedfit



PART NO.	SUPERSEAL OD	SPEEDFIT OD
SM420808S	5/16	5/16
SI421012S	5/16	3/8
SI421210S	3/8	5/16
SI421212S	3/8	3/8

SUPERSEAL SPANNER



PART NO.
SPAN1

John Guest Adaptability

Standard **Super Speedfit** products can be coupled together to form integral new fittings.

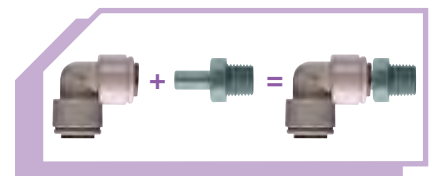

Accessories for Superseal Fittings are shown on page 33.



Brass Fittings for beverage dispense applications

Designed for use in coffee brewing equipment, dispensing and vending machine applications. The fittings are manufactured in brass with a polypropylene collet and a food grade EPDM 'O' ring.

Working Pressures and Temperatures

Water	10 Bar at 20°C
	4 Bar at 60°C
Minimum Temperature	1°C

Other technical information is shown on page 36.



BRASS FEMALE CONNECTOR

FFL Thread



PART NO.	TUBE OD	THREAD FFL
MI4508F4S	1/4	x 1/4
MI4512F4S	3/8	x 1/4
MI4512F6S	3/8	x 3/8

1/4 (FFL) corresponds to a 7/16 UNF
3/8 (FFL) corresponds to a 5/8 UNF

BRASS FEMALE CONNECTOR

GH Thread



PART NO.	TUBE OD	THREAD GH
NC2098	1/4	x 3/4

A stem elbow shown on page 08 will provide a neat 90° installation. The tube can be orientated in any direction.

BRASS POLYPROPYLENE FEMALE CONNECTOR

BSPP Thread



PART NO.	TUBE OD	THREAD BSPP
NC2145	1/4	x 3/4
NC2249	3/8	x 3/4

Metric to Imperial Adaptors

STRAIGHT CONNECTOR



PART NO.	TUBE OD	TUBE OD
NC462	15mm	- 1/2"

STEM TO TUBE ADAPTOR



PART NO.	STEM OD	TUBE OD
NC2164	15mm	- 3/8"
NC2173	1/2"	- 15mm

ADAPTOR TEE



PART NO.	TUBE OD END	TUBE OD BRANCH
NC869	15mm	3/8"

STRAIGHT CONNECTOR



PART NO.	SUPERSEAL OD	SPEEDFIT OD
NC2301	1/2"	- 15mm

STEM TO HOSE CONNECTOR



PART NO.	STEM OD	HOSE ID
NC932	15mm	- 1/2"

STEM TO STEM ADAPTOR



PART NO.	STEM OD	STEM OD
NC478	15mm	- 3/8"

UNEQUAL STRAIGHT CONNECTOR



PART NO.	TUBE OD	TUBE OD
NC2511	15mm	- 3/8"

TUBE TO HOSE CONNECTOR



PART NO.	TUBE OD	HOSE ID
NC448	15mm	- 1/2"

CM Fittings for drinks and other potable liquids

CM range of metric size fittings are manufactured in acetal. With a food grade EPDM 'O' ring, they have been developed for the water industry but are equally suitable for other potable liquids. They are also recommended for intermittent hot water applications.

The CM Range is NOT suitable for compressed air and vacuum applications. For these situations we recommend the PI Range on pages 7 - 12 and the PM Range on Pages 23 - 26.

Working Pressures and Temperatures

Water 10 BAR at 20°C
7 BAR at 65°C intermittent hot water

Other technical information is shown on page 36.

FEMALE ADAPTOR BSP Thread

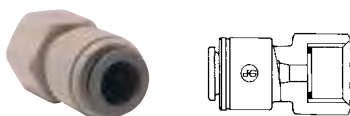

PART NO.	TUBE OD	THREAD BSP
CM451213FS	12 x	3/8
CM451214FS	12 x	1/2
CM451513FS	15 x	3/8

TAP ADAPTOR Flat End BSP Thread



PART NO.	TUBE OD	THREAD BSP
CM320816FE	8 x	3/4

END STOP



PART NO.	TUBE OD
CM4612W	12

TAP ADAPTOR UNS Thread



PART NO.	TUBE OD	THREAD UNS
CM3210U7E	10 x	7/16 - 24

TWO WAY DIVIDER



PART NO.	TUBE OD
CM2315W	15

TAP ADAPTOR BSP Thread



PART NO.	TUBE OD	THREAD BSP
CM320616E	6 x	3/4
CM320816E	8 x	3/4
CM321014E	10 x	1/2
CM321216E	12 x	3/4

STRAIGHT ADAPTOR



PART NO.	TUBE OD	THREAD BSP
CM011514S	15 x	1/2

Black Acetal Fittings

The PM Range of metric size fittings is manufactured in black acetal copolymer with food grade nitrile 'O' rings. Being especially produced for foodstuff and potable liquids, they are equally suitable for air and inert gases and can therefore be used on N²/CO² (installed in accordance with the Brewers and Licensed Retailers Association code of practice) mixed gas dispense lines and pneumatic applications and vacuum.

Technical Information shown on page 36.



STRAIGHT ADAPTOR

BSP Thread



PART NO.	TUBE OD	THREAD BSP
PM010411E	4	x 1/8
PM010412E	4	x 1/4
PM010511E	5	x 1/8
PM010512E	5	x 1/4
PM010611E	6	x 1/8
PM010612E	6	x 1/4
PM010811E	8	x 1/8
PM010812E	8	x 1/4
PM010813E	8	x 3/8
PM011012E	10	x 1/4
PM011013E	10	x 3/8
PM011014E	10	x 1/2
PM011213E	12	x 3/8
PM011214E	12	x 1/2
PM011513E**	15	x 3/8
PM011514E	15	x 1/2
PM011516E *	15	x 3/4
PM011814E	18	x 1/2
PM012216E	22	x 3/4

* No thread seal

** New

STRAIGHT ADAPTOR

BSPT Thread



PART NO.	TUBE OD	THREAD BSPT
PM010401E	4	x 1/8
PM010402E	4	x 1/4
PM010501E	5	x 1/8
PM010502E	5	x 1/4
PM010601E	6	x 1/8
PM010602E	6	x 1/4
PM010801E	8	x 1/8
PM010802E	8	x 1/4
PM010803E	8	x 3/8
PM011002E	10	x 1/4
PM011003E	10	x 3/8
PM011004E	10	x 1/2
PM011203E	12	x 3/8
PM011204E	12	x 1/2

PART NO.	TUBE OD	THREAD NPTF
PM010622E	6	x 1/4

EQUAL STRAIGHT CONNECTOR



PART NO.	TUBE OD
PM0404E	4
PM0405E	5
PM0406E	6
PM0408E	8
PM0410E	10
PM0412E	12
PM0415E	15
PM0418E	18
PM0422E	22

REDUCING STRAIGHT CONNECTOR



PART NO.	TUBE OD	TUBE OD
PM200604E	6	- 4
PM200804E	8	- 4
PM200806E	8	- 6
PM201004E	10	- 4
PM201006E	10	- 6
PM201008E	10	- 8
PM201208E	12	- 8
PM201210E	12	- 10

EQUAL ELBOW



PART NO.	TUBE OD
PM0304E	4
PM0305E	5
PM0306E	6
PM0308E	8
PM0310E	10
PM0312E	12
PM0315E	15
PM0318E	18
PM0322E	22

REDUCING ELBOW CONNECTOR



PART NO.	TUBE OD	TUBE OD
PM210604E	6	- 4
PM210804E	8	- 4
PM210806E	8	- 6
PM211004E	10	- 4
PM211006E	10	- 6
PM211008E	10	- 8
PM211208E	12	- 8
PM211210E	12	- 10

STEM ELBOW



PART NO.	TUBE OD	STEM OD
PM220404E	4	- 4
PM220505E	5	- 5
PM220606E	6	- 6
PM220808E	8	- 8
PM221010E	10	- 10
PM221212E	12	- 12
PM221515E	15	- 15
PM221818E	18	- 18
PM222222E	22	- 22

RIGID ELBOW



PART NO.	TUBE OD	THREAD NPTF
PM480621E	6	x 1/8
PM480622E	6	x 1/4
PM480623E	6	x 3/8

for liquids & inert gases

SWIVEL ELBOW

BSP Thread



PART NO.	STEM OD	THREAD BSP
PM090411E	4 x	1/8
PM090412E	4 x	1/4
PM090511E	5 x	1/8
PM090512E	5 x	1/4
PM090611E	6 x	1/8
PM090612E	6 x	1/4
PM090811E	8 x	1/8
PM090812E	8 x	1/4
PM090813E	8 x	3/8
PM091012E	10 x	1/4
PM091013E	10 x	3/8
PM091014E	10 x	1/2
PM091213E	12 x	3/8
PM091214E	12 x	1/2

REDUCING TEE



PART NO.	TUBE OD ENDS	TUBE OD BRANCH
PM3006AE	4 -	6
PM3018AE	18 -	15
PM3022AE	22 -	15

SWIVEL MALE RUN TEE

BSP Thread



PART NO.	TUBE OD	THREAD BSP
PM110411E	4 x	1/8
PM110412E	4 x	1/4
PM110511E	5 x	1/8
PM110512E	5 x	1/4
PM110611E	6 x	1/8
PM110612E	6 x	1/4
PM110811E	8 x	1/8
PM110812E	8 x	1/4
PM110813E	8 x	3/8
PM111012E	10 x	1/4
PM111013E	10 x	3/8
PM111014E	10 x	1/2
PM111213E	12 x	3/8
PM111214E	12 x	1/2

SWIVEL TEE

Centre Leg BSP Thread



PART NO.	TUBE OD	THREAD BSP
PM100411E	4 x	1/8
PM100412E	4 x	1/4
PM100511E	5 x	1/8
PM100512E	5 x	1/4
PM100611E	6 x	1/8
PM100612E	6 x	1/4
PM100811E	8 x	1/8
PM100812E	8 x	1/4
PM100813E	8 x	3/8
PM101012E	10 x	1/4
PM101013E	10 x	3/8
PM101014E	10 x	1/2
PM101213E	12 x	3/8
PM101214E	12 x	1/2

SWIVEL MALE RUN TEE

BSPT Thread



PART NO.	TUBE OD	THREAD BSPT
PM110401E	4 x	1/8
PM110402E	4 x	1/4
PM110501E	5 x	1/8
PM110502E	5 x	1/4
PM110601E	6 x	1/8
PM110602E	6 x	1/4
PM110801E	8 x	1/8
PM110802E	8 x	1/4
PM110803E	8 x	3/8
PM111002E	10 x	1/4
PM111003E	10 x	3/8
PM111004E	10 x	1/2
PM111203E	12 x	3/8
PM111204E	12 x	1/2

SWIVEL ELBOW

BSPT Thread



PART NO.	TUBE OD	THREAD BSPT
PM090401E	4 x	1/8
PM090402E	4 x	1/4
PM090501E	5 x	1/8
PM090502E	5 x	1/4
PM090601E	6 x	1/8
PM090602E	6 x	1/4
PM090801E	8 x	1/8
PM090802E	8 x	1/4
PM090803E	8 x	3/8
PM091002E	10 x	1/4
PM091003E	10 x	3/8
PM091004E	10 x	1/2
PM091203E	12 x	3/8
PM091204E	12 x	1/2

SWIVEL TEE

Centre Leg BSPT Thread



PART NO.	TUBE OD	THREAD BSPT
PM100401E	4 x	1/8
PM100402E	4 x	1/4
PM100501E	5 x	1/8
PM100502E	5 x	1/4
PM100601E	6 x	1/8
PM100602E	6 x	1/4
PM100801E	8 x	1/8
PM100802E	8 x	1/4
PM100803E	8 x	3/8
PM101002E	10 x	1/4
PM101003E	10 x	3/8
PM101004E	10 x	1/2
PM101203E	12 x	3/8
PM101204E	12 x	1/2

EQUAL TEE



PART NO.	TUBE OD
PM0204E	4
PM0205E	5
PM0206E	6
PM0208E	8
PM0210E	10
PM0212E	12
PM0215E	15
PM0218E	18
PM0222E	22

John Guest Adaptability

Standard *Super Speedfit* products can be coupled together to form integral new fittings.

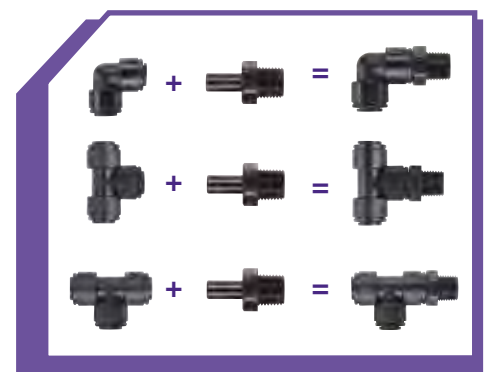

BULKHEAD CONNECTOR

PART NO.	TUBE OD
PM1204E	4
PM1205E	5
PM1206E	6
PM1208E	8
PM1210E	10
PM1212E	12

For 1/4" x 6mm size
see page 11

REDUCER

PART NO.	STEM OD	TUBE OD
PM060504E	5	4
PM060604E	6	4
PM060605E	6	5
PM060804E	8	4
PM060805E	8	5
PM060806E	8	6
PM061006E	10	6
PM061008E	10	8
PM061208E	12	8
PM061210E	12	10
PM061510E	15	10
PM061512E	15	12
PM061815E	18	15
PM062215E	22	15
PM062218E	22	18

ENLARGER

PART NO.	TUBE OD	STEM OD
PM130405E	5	4

STEM ADAPTOR

BSP Thread



PART NO.	STEM OD	THREAD BSP
PM050411E	4	x 1/8
PM050412E	4	x 1/4
PM050511E	5	x 1/8
PM050512E	5	x 1/4
PM050611E	6	x 1/8
PM050612E	6	x 1/4
PM050811E	8	x 1/8
PM050812E	8	x 1/4
PM050813E	8	x 3/8
PM051012E	10	x 1/4
PM051013E	10	x 3/8
PM051014E	10	x 1/2
PM051213E	12	x 3/8
PM051214E	12	x 1/2
PM051513E	15	x 3/8
PM051514E	15	x 1/2
PM051814E	18	x 1/2
PM052214E	22	x 1/2
PM052216E	22	x 3/4

STEM ADAPTOR

BSPT Thread



PART NO.	STEM OD	THREAD BSPT
PM050401E	4	x 1/8
PM050402E	4	x 1/4
PM050501E	5	x 1/8
PM050502E	5	x 1/4
PM050601E	6	x 1/8
PM050602E	6	x 1/4
PM050801E	8	x 1/8
PM050802E	8	x 1/4
PM050803E	8	x 3/8
PM051002E	10	x 1/4
PM051003E	10	x 3/8
PM051004E	10	x 1/2
PM051203E	12	x 3/8
PM051204E	12	x 1/2

TWO-WAY DIVIDER

PART NO.	TUBE OD
PM2304E	4
PM2308E	8
PM2310E	10

TWO-WAY DIVIDER

PART NO.	TUBE OD
PM2315E	15

For the new BDA Approved Twin Recirc. Python for coolant water feed and return

PLUG

PART NO.	STEM OD
PM0804R	4
PM0805R	5
PM0806R	6
PM0808R	8
PM0810R	10
PM0812R	12
PM0815E	15
PM0818E	18
PM0822E	22

4mm - 12mm sizes in red
15mm - 22mm sizes in black
8mm size also available in black Part No. PM0808E

TUBE TO HOSE STEM



PART NO.	STEM OD	HOSE ID
PM250604E	6	4
PM250806E	8	6
PM251008E	10	8

OFFSET CONNECTOR



PART NO.	TUBE OD	TUBE OD
NC657	12	8

END STOP



PART NO.	TUBE OD
PM4612E	12
PM4615E	15
PM4622E	22

U-BEND



PART NO.	TUBE OD
PMUB15E	15

FEMALE ADAPTOR



PART NO.	TUBE OD	THREAD
PM450411E*	4	x 1/8 BSP
PM450611E	6	x 1/8 BSP
PM450612E*	6	x 1/4 BSP
PM450812E	8	x 1/4 BSP
PM450813E	8	x 3/8 BSP
PM451015FE*	10	x 5/8 BSP
PM451215FE	12	x 5/8 BSP

* With thread seal.
Other sizes no seal.



White Polypropylene Fittings

The PPM Range of metric size push-fit fittings are produced in white polypropylene and fitted with EPDM seals.

Polypropylene has the advantage of being more chemically resistant than acetal.

Working Pressures and Temperatures

Water 10 BAR at 20°C
4 BAR at 60°C intermittent hot water

Minimum Temperature 1°C

Other technical information is shown on page 36.



EQUAL STRAIGHT CONNECTOR



PART NO.	TUBE OD
PPM0408W	8
PPM0412W	12

STEM ELBOW



PART NO.	STEM OD	TUBE OD
PPM220808W	8	8
PPM221212W	12	12

PLUG



PART NO.	STEM OD
PPM0808W	8

REDUCING STRAIGHT CONNECTOR



PART NO.	TUBE OD	TUBE OD
PPM201512W	15	12

EQUAL TEE



PART NO.	TUBE OD
PPM0208W	8
PPM0212W	12

DIVIDER



PART NO.	TUBE OD
PPM2312W	12

EQUAL ELBOW



PART NO.	TUBE OD
PPM0308W	8
PPM0312W	12

REDUCER



PART NO.	STEM OD	TUBE OD
PPM061512W	15	12

Adaptors to convert to Metric sizes are shown on page 19.



Acetal Angle Stop Valves

John Guest Angle Stop Valves are manufactured in Acetal with EPDM 'O' rings. They incorporate a single check valve and a 1/4 turn chromium plated ball valve.

The valves are for use with potable water. For use with other potable liquids please refer to our Customer Services Department for guidance.

The valves are not to be used with compressed air, explosive gases, petroleum spirit and other fuels or for heating systems.

Working Pressures and Temperatures

Water 12 Bar at 20°C
 6 Bar at 65°C



ACETAL ANGLE STOP VALVE ●



PART NO.	TUBE OD	TUBE OD BRANCH
ASV3	15mm	1/4"
ASV4	15mm	3/8"



PART NO.	THREAD BSP	THREAD BSP	TUBE OD BRANCH
ASV7	3/8	3/8	3/8
ASV8	1/2	1/2	3/8
ASV9	3/8	3/8	1/4
ASV10	1/2	1/2	1/4

Acetal Elbow Stop Valves

The Elbow Stop Valve has an Acetal body and is fitted with EPDM seals and a brass nut.

Suitable for applications in the Drinks Dispense and Pure Water Industries.

The Valves should not be used with compressed air, explosive gases, petroleum spirits and other fuels or for heating systems.

Working Pressures and Temperatures

Water 10 Bar at 23°C
 7 Bar at 65°C

ACETAL ELBOW STOP VALVE ●



PART NO.	TUBE OD	THREAD BSP
PISVBTC1214	3/8	1/2

1/4 Turn Valves. These valves have been designed to allow temporary servicing of downstream equipment and must only be used in the fully open or fully closed position.

DO NOT USE THESE VALVES:

- In a partially open position to control flow.
- To provide a permanent termination.
- Without tubing assembled or plugged (or threaded connections sealed).
- As a tap or "faucet".

1/4 Turn Valves are indicated by this marker ●●

Polypropylene Shut-Off Valve

The PP Range of shut-off valves are produced in polypropylene and fitted with EPDM seals. Polypropylene has the advantage of being more chemically resistant than acetal.

The valves are for use with potable water. For use with other potable liquids please refer to our Customer Services Department for guidance.

The valves are not to be used with compressed air, explosive gases, petroleum spirits and other fuels or for heating systems.

Working Pressures and Temperatures

Water	10 Bar at 20°C
	4 Bar at 60°C
Minimum Temperature	1°C

For advice on the use of 1/4 turn valves see Technical Specification on page 36.



White polypropylene for Potable Water

SPEEDFIT TO SPEEDFIT ●



PART NO.	TUBE OD
PPSV040808W	1/4
PPSV041212W	3/8
PPMSV040606W	6mm
PPMSV040808W	8mm
PPMSV041010W	10mm
PPMSV041212W	12mm

8mm also available with mounting clip supplied unassembled **PPMSV04KIT**

SPEEDFIT TO FEMALE ● NPTF



PART NO.	TUBE OD	THREAD NPTF
PPSV500822W	1/4	1/4
PPSV501222W	3/8	1/4

1/4 Turn Valves. These valves have been designed to allow temporary servicing of downstream equipment and must only be used in the fully open or fully closed position.

DO NOT USE THESE VALVES:

- In a partially open position to control flow.
- To provide a permanent termination.
- Without tubing assembled or plugged (or threaded connections sealed).
- As a tap or "faucet".

1/4 Turn Valves are indicated by this marker '●'

MOUNTING CLIP



PART NO.	
SVMC-06	For 6mm and 1/4"
SVMC-10	For 10mm and 3/8"

The mounting clip is designed to give a very firm grip. A twisting action is needed to remove the valve. The clip can be used with either shut off valve. When used with the short handle version, valves can be banked together.

SPEEDFIT TO MALE ● NPTF



PART NO.	TUBE OD	THREAD NPTF
PPSV010822W	1/4	1/4
PPSV011223W	3/8	3/8

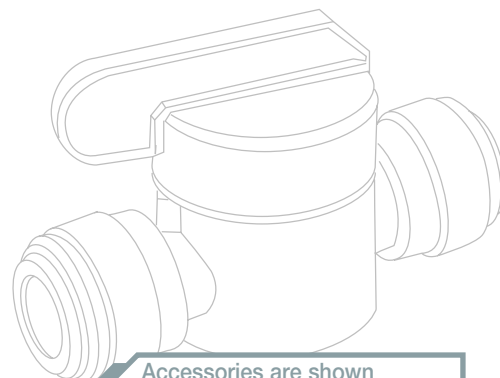

Accessories are shown on page 33.

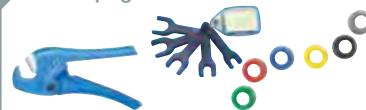

Acetal Shut-Off Valve

John Guest acetal shut-off valves have a brand new full bore mechanism and are especially designed for the Brewing and Soft Drinks Industries and for potable water.

They are also suitable for air and inert gases such as N²/CO².

The range includes valves with short and long handles to operate a 1/4 turn on off action.

Some valves are available with or without mounting clip. Others have integral mounting bosses.

Working Temperatures & Pressures

Air	-20°C	10 bar
Air / Potable Liquids	+1°C	10 bar
	+23°C	10 bar
	+65°C	7 bar

For cleaning and sanitising and for advice on the use of 1/4 turn valves see Technical Specification on page 36.



Can also be used with N²/CO² to a maximum temperature of 50°C. When being used with N²/CO², the valve should be installed in accordance with The British Beer and Pub Association Code of Practice.

Grey acetal for liquids & inert gases

SHUT OFF VALVE • Short Handle



PART NO.	TUBE OD
----------	---------

PISV0412CS	3/8
------------	-----

SHUT OFF VALVE • LONG HANDLE WITH MOUNTING CLIP



PART NO.	TUBE OD
----------	---------

PISV04KIT	3/8
-----------	-----

supplied unassembled

1/4 Turn Valves. These valves have been designed to allow temporary servicing of downstream equipment and must only be used in the fully open or fully closed position.

DO NOT USE THESE VALVES:

- In a partially open position to control flow.
- To provide a permanent termination.
- Without tubing assembled or plugged (or threaded connections sealed).
- As a tap or "faucet".

1/4 Turn Valves are indicated by this marker '•'

SHUT OFF VALVE • Short Handle with Mounting Clip



PART NO.	TUBE OD
----------	---------

PISV04KIT-SH	3/8
--------------	-----

supplied unassembled

ANGLE STOP VALVE •



PART NO.	TUBE OD
----------	---------

NC2555	3/8
--------	-----

The John Guest 3/8" Angle Stop Valve features double 'O' rings in each of the Speedfit ports and has been developed for a wide range of applications including foodstuffs, potable liquids and air.

SHUT OFF VALVE • Long Handle



PART NO.	TUBE OD
----------	---------

PISV0412S	3/8
PISV0416S	1/2

Check Valves & Service Valves

Single Check Valves

Produced at the request of leading companies in the Drinks Dispense Industry, the Super Speedfit acetal Single Check Valve ensures protection against reversal of flow.

The low headloss design and fast installation time makes the valve the ideal selection. The valve is designed for use with liquids, it is not suitable for air and vacuum applications.

Working Pressures and Temperatures

10 Bar at 20°C

7 Bar at 65°C intermittent hot water

Minimum Temperature 1°C

Typical 'crack open' pressure 0.02 Bar

Technical information other than working pressures and temperatures shown on page 36.



SINGLE CHECK VALVE



PART NO.	TUBE OD
1/4SCV	1/4"
5/16SCV	5/16"
3/8SCV	3/8"

For use with liquids only.

SINGLE CHECK VALVE



PART NO.	TUBE OD
6SCV	6mm
10SCV	10mm
12SCV	12mm

For use with liquids only.

SINGLE CHECK VALVE



PART NO.	TUBE OD
NC2718	1/4"

5psi Crack Open Pressure.
For use with liquids only.

- Valves with low fixed cracking pressure (i.e 10cm water column), that have not been activated for some time may take several seconds to re-seal.
- It is the responsibility of the end user to verify that the product is suitable for his specific application.
- It is also recommended that the non-return valve is regularly checked and maintained.



Double Check Valve

Double Check Valves ensure the prevention of contamination arising from back syphonage, back flow and cross connection.

A spring loaded internal check valve is sited either side of the test cock and an arrow identifies the direction of flow. The low headloss design and fast installation time makes this unit the ideal selection. The valve can be mounted in any position.

The valve can also be used for domestic hot and cold water supplies.

Working Pressures and Temperatures

10 Bar at 20°C
7 Bar at 65°C intermittent hot water

Technical information other than working pressures and temperatures shown on page 36.

Service Valves

Speedfit Service Valves are ideally suited to provide a temporary shut-off facility in a drinks dispense situation.

The valve consists of a ball mechanism operated by means of a screwdriver slot

Push in connections make for a fast installation time, especially in confined spaces.

The valves can also be used for domestic hot and cold water supplies.

Working Pressures and Temperatures

10 Bar at 20°C
7 Bar at 65°C intermittent hot water

Technical information other than working pressures and temperatures shown on page 36.

DOUBLE CHECK VALVE



PART NO.	TUBE OD
15DCV	15mm

For use with liquids only.

SERVICE VALVE ●



PART NO.	TUBE OD
15SV	15mm

For use with liquids only.

NEW DOUBLE CHECK SERVICE VALVE ●



PART NO.	TUBE OD
15DCSV	15mm

For use with liquids only.

SERVICE VALVE ●



PART NO.	TUBE OD
1/2ISV	1/2"

For use with liquids only.

1/4 Turn Valves. These valves have been designed to allow temporary servicing of downstream equipment and must only be used in the fully open or fully closed position.

DO NOT USE THESE VALVES:

- In a partially open position to control flow.
- To provide a permanent termination.
- Without tubing assembled or plugged (or threaded connections sealed).
- As a tap or "faucet".

1/4 Turn Valves are indicated by this marker '●'

10 8 Coils Strong

LLDPE Tubing

The John Guest PE Range of plastic tubing is produced in Linear Low Density Polyethylene for cold and intermittent hot water applications.

Our tubing provides the benefits of a wide range of temperature and pressure suitability, broad chemical compatibility and is made from non contaminating materials. Common applications are in water purification, water conditioners, ice makers and misting systems. LLDPE is more robust than traditional low or medium density polyethylene and is recommended for use with cold and intermittent hot water. Our tubing is made from FDA compliant materials and is NSF International certified. John Guest LLDPE Tubing provides excellent resistance to environmental stress cracking as measured by ASTM D-1693 (10% IGEPAL).

John Guest Polyethylene tubing is designed for use with John Guest Super Speedfit push-fit fittings, John Guest Shut-Off Valves and virtually all standard tubing connectors.

Sizes Available

PART NO.	OD	ID LENGTH	COIL RADII	MINI BEND
PE-08-BI-0500F-N	1/4"(0.250")	0.170"	500 FT	1.00"
PE-08-BI-1000F-N	1/4"(0.250")	0.170"	1000FT	1.00"
PE-10-CI-0500F-N	5/16"(0.312")	0.187"	500 FT	1.13"
PE-12-EI-0500F-N	3/8"(0.375")	0.250"	500 FT	1.25"
PE-16-GI-0250F-N	1/2"(0.500")	0.375"	250 FT	2.50"
PE-04025-0100M-N	4mm	2.5mm	100m	25mm
PE-0604-0100M-N	6mm	4mm	100m	25mm
PE-0806-0100M-N	8mm	6mm	100m	30mm
PE-1007-100M-N	10mm	7mm	100m	32mm
PE-1209-100M-N	12mm	9mm	100m	63mm
PE-15115-0100M	15mm	11.5mm	100m	100mm

Tube Tolerances

1/4" to 1/2"	+0.001/-0.004"
4mm	+0.05/-0.07mm
6mm to 12mm	+0.05/-0.10mm
15mm	+0.10/-0.10mm

N denotes natural colour. To request other colours please refer to table below. Popular items are now generally in stock and are available in minimum quantities of 2 coils. Other items may be subject to longer lead times and are available in minimum quantities of 50 coils.

Standard Colours Available

SUFFIX

N
NATURAL



B
BLUE

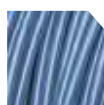

E
BLACK



R
RED



W
WHITE



Other special colours available on request:-

Orange (O)
Green (G)
Yellow (Y)

15mm size only available in Blue, Red and Green.

8mm size only available in Natural, Blue, Black, Red and White.

For other colours we suggest you use 5/16".

Black tubing is UV stabilized.

Sizes ours yet flexible



NSF 51
NSF 61

Working Temperatures and Pressures - LLDPE

TUBE OD		TUBE ID	
1/4"	x	0.170"	230 psi @70°F
5/16"	x	0.187"	16 bar @20°C
3/8"	x	0.25"	
4mm	x	2.5mm	120 psi @150°F
6mm	x	4mm	8 bar @ 65°C
10mm	x	7mm	
1/2"	x	0.375"	150 psi @70°F
8mm	x	6mm	10 bar @20°C
12mm	x	9mm	
15mm	x	11.5mm	90 psi @150°F
			6 bar @65°C

1 Bar = 14.5 psi (approx.)

Maximum Working Temperature 150°F at pressures shown in chart above.

For temperatures above 150°F customers should refer to our Technical Help Desk.

The above maximum temperatures and pressures do not take chlorine content into account. This could reduce service life.

Please note maximum pressure rating for a 'system' depends on the lowest rated component, eg. most John Guest fittings have a different rating from the tube ratings shown above.

Burst Pressures are approximately 3 times the maximum working pressure.

Pneumatics Applications

John Guest LLDPE tube is suitable for pneumatic applications providing pressure is maximum 10 bar @ 20°C (150psi @ 70°F). At elevated temperatures(50°C+) mineral oil will degrade LLDPE tube and, therefore, LLDPE tube used in pneumatic circuits should be periodically checked and replaced if necessary.

Tube Inserts

If the tube is used in a warm water system a tube insert is necessary.

Exposure to Ultraviolet Light

Only black or blue tube should be installed in areas exposed to any light if biofilm growth is considered an issue. In this case other colours must be protected from exposure to light. Black tube is also UV stabilised and can be installed where exposed to direct sunlight (UV).

Chemical Resistance

For use of LLDPE with chemicals or potentially aggressive liquids, please refer to our Technical Service Department.

NOTE: When using cleaning agents or other potentially aggressive liquids, please ensure compatibility with tubing and fittings. LLDPE is not recommended for mineral oils, gases and fuels or high pressure compressed air / pneumatic systems.

Potable Water Applications

John Guest LLDPE tubing is suitable for potable cold water applications with a maximum chlorine content of 4 parts per million (4 ppm). Heating water above 70°F (20°C) and or pressures above the maximum will significantly reduce service life. Direct exposure to sunlight will also significantly reduce its useful service. As part of good practice tubing should be inspected regularly. If there is any evidence of damage, hardening or cracking it should be replaced immediately.

Accessories

COLLET COVERS



The slip-on Collet Cover shown in the illustration prevents accidental removal or tampering with tubing. Tubing can be inserted with the Collet Cover already attached to the fittings or the cover can slide into position afterwards. The cover is easily removed when required and comes in a variety of colours for colour coding.

Colours available - Suffix indicates colours
 E = Black Y = Yellow B = Blue
 R = Red S = Grey G = Green

INCH SIZE

PART NO.	TUBE OD
PM1904S	5/32
PI1906S	3/16
PI1908S	1/4
PM1908S	5/16
PI1912S	3/8
PI1916S	1/2

Please indicate by suffix, colour required or grey will be supplied.

METRIC SIZE

PART NO.	TUBE OD
PM1904E	4
PM1905E	5
PM1906E	6
PM1908E	8
PM1910E	10
PM1912E	12
PM1915E	15
PM1918E	18
PM1922E	22

15mm to 22mm sizes available in black as standard, white red or blue

Please indicate by suffix, colour required or black will be supplied.

FLOW BEND CLIP



PART NO.	TUBE OD
PM2608S	8mm/5/16
PM2610S	10mm/3/8
PM2612S	12mm/1/2

Designed to support tube and eliminate kinking.

TUBE INSERT



PART NO.	TUBE OD	TUBE ID
TSI250S	3/8	1/4
TSI312S	3/8	5/16
TSI375S	1/2	3/8

PART NO.	TUBE OD	TUBE ID
TSM1209S	12mm	9mm

TUBE INSERT



PART NO.	TUBE OD	TUBE ID
TSM10N	10	7
TSM1209S	12	9
TSM15N	15	11.5

PLUG



PART NO.	STEM OD
PM0804R	4
PM0805R	5
PM0806R	6
PM0808R	8
PM0810R	10
PM0812R	12
PM0815E	15
PM0818E	18
PM0822E	22

4mm - 12mm sizes in red.
 15mm - 22mm sizes in black.
 8mm size also available in black Part No. PM0808E.

COLLET LOCKING TOOL



PART NO.	SIZE
ICLT/2	3/16 to 1/2

TUBE CUTTER



PART NO.	PART NO.
TS NIP	BLADES

Suitable for up to 12mm tube.

PIPE CUTTER



PART NO.
JG-TS

Suitable for up to 22mm tube.

LOCKING CLIP



PART NO.	TUBE OD
INCH SIZE	
PIC1808R	1/4
PMC1808R	5/16
PIC1812R	3/8
PIC1816R	1/2

METRIC SIZE	
PMC1815R	15mm



Secures the collet in its position to prevent an accidental disconnection of the tube.

Technical Specification

Working Pressure and Temperature Range

Super Speedfit fittings are suitable for the following pressures and temperatures.

Temp.	Pressure	
	5/32" - 5/16" 4mm - 8mm	3/8" - 1/2" 10mm - 22mm
Air		
- 20°C	16 Bar	10 Bar
Potable Liquids and Air		
+1°C	16 Bar	10 Bar
+20°C	16 Bar	10 Bar
+65°C	10 Bar	7 Bar

Also suitable for vacuum

Depending on the tube used, under certain conditions fittings may be used at higher pressures and temperatures. Please refer to our Customer Services Department for guidance. Note 1 Bar = 14.5 PSIG.

Tube Types

Plastic Tube - Polyethylene, nylon and polyurethane conforming to the tolerances shown below. For soft tubing or thin wall tube we recommend the use of tube inserts.

Braided Tube - Use of Tube to Hose Stems listed on pages 5 and 12 is essential when using tube. Use of clamps to retain braided tube on barbs is recommended.

Metal Tube (soft) - Brass, copper or mild steel conforming to the tolerances below.

Metal Tube (hard) - We do not recommend Super Speedfit fittings for hard metal or chromium plated tubes.

For stainless steel and other polished metal tubes we recommend the use of Superseal fittings. These are shown on page 9 of this brochure. It is essential that outside diameters be free from score marks and that the tube be deburred before inserting the fitting.

Tube Tolerances

Super Speedfit fittings are offered for tubes with outside diameters to the following tolerances.

Size (inches)	5/32 - 3/16	1/4 - 1/2
Tolerance (inches)	+0.001 / -0.003	+0.001 / -0.004
Size (mm)	4mm - 5mm	6mm - 22mm
Tolerance (mm)	+0.05 / -0.07	+0.05 / -0.10

Installation and System Testing

Fittings and tube should be kept clean and undamaged before use.

All tube and fittings installations must be pressure tested after installation to ensure system integrity before handing over to the final user. See also "How to make a connection".

1/4 Turn Valves

These valves have been designed to allow temporary servicing of downstream equipment and must only be used in the fully open or fully closed position. **DO NOT USE THESE VALVES: In a partially open position to control flow; to provide a permanent termination; without tubing assembled or plugged (or threaded connections sealed, or as a tap or "faucet").**

Chemicals

For use with chemicals or other potentially aggressive liquids, please refer to our Customer Services Department. In general, use only water or oil based paint. DO NOT ALLOW CONTACT WITH Cellulose based paint, paint thinners or strippers, solder flux or aggressive cleaners (see Cleaners and Sanitising). Keep away from ozone generators such as electric motors, mercury vapour lamps and high voltage electrical equipment.

Super Speedfit fittings are not recommended for use with explosive gases, petroleum spirits, and other fuels or for central heating systems.

Collet Covers

Are available as additional security against removal of the tube or to provide a simple means of colour coding. The cover is offered in a range of six colours. Please see page 26 of this brochure.

Food Quality

All the fittings in the brochure are produced in Food and Drug Administration (FDA) approved materials and are therefore recommended for food quality applications.

Maximum Torque Values for

Plastic Threads BSP, BSPT & NPT.

Plastic threads are not generally as strong as brass threads. Customers and end users should be aware of this when choosing products for their applications. Overtightening of plastic threads will cause undue stress and eventual cracking and leakage. The maximum torque figures for BSP and BSPT threads used on John Guest fittings in mating threads conforming to the relevant BS or International thread standards are shown below.

	Threads		
	1/8 - 1/4	3/8 - 1/2	3/4
Max. Torque	1.5Nm	3.0Nm	4.0Nm

John Guest recommend OEM customers to consider replacing threaded ports with the more modern Cartridge Systems.

It is recommended that all installations are checked prior to use to determine that a seal has been made.

Maintenance and Replacement Intervals

John Guest products generally require little maintenance but as a minimum we recommend routine visual inspection. Frequency of visual inspection will depend on severity of application and risk of failure. If after visual inspection John Guest products appear damaged, cracked, charred, discoloured, heat distorted or corroded they should be replaced. Any product that is or appears to be leaking should be replaced.

Product life is affected by the severity of the application, the hostility of the working environment and contact with aggressive chemicals or liquids. It is therefore important that specific replacement intervals be considered by specifiers/users/customers based on previous service life or when failure could result in unacceptable downtime, damage or injury risk.

Cleaners and Sanitising of Fittings

The external surfaces of John Guest products must not come into contact with oxidising or acidic cleaners and sanitising agents, for example (but not limited to) those below pH 4, high in sodium hypochlorite level (bleach) or containing hydrogen peroxide. Our plastic material suppliers recommend ECOLAB Oasis 133 as a suitable cleaner for the external surfaces of products manufactured by John Guest.

Several different methods exist for sanitising the internal surfaces of fluid systems, including sodium hypochlorite, hydrogen peroxide, chlorine dioxide or ozone. It is entirely the responsibility of the end user to determine if the chosen method is suitable for use with John Guest products over the planned working life of the system. However, to avoid unnecessary early failure, John Guest requires that the disinfection solution must be immediately flushed out at all draw off points with fresh, wholesome water at the end of the disinfection period. **The solution must not be left in the system.** Disinfection solutions must only come into contact with the internal (fluid carrying) surfaces of the system. If any other surfaces of a fitting come into contact with disinfection solution **the whole fitting must be replaced immediately.** Polypropylene fittings offer greater resistance to aggressive chemicals than Acetal fittings but do not have the same mechanical properties. John Guest polypropylene fittings are generally designated by the part number prefix PP or PPM.

Side Loads

John Guest products are not designed to be used whilst under side load as this may adversely affect their ability to function long-term. Always ensure tubes have good alignment with the fitting. They must also not be subjected to any form of impact or other damage, such as being hit or dropped, even accidentally. If fittings have damaged or suffered an impact, they should be replaced immediately. John Guest warranty does not cover loss caused by any form of damage.

Warranty

Whilst we give a warranty against defects in manufacture or materials, it is the responsibility of the specifier to ensure that fittings and related products are suitable for their application. The installation must be carried out correctly in accordance with our recommendations, complying with recognised codes of practice and relevant national standards, and be properly maintained. Please refer to our terms and conditions of sale.

John Guest International Limited



John Guest Limited

Horton Road, West Drayton, Middlesex UB7 8JL, UK.

Tel: (00 44) (0) 1895 449233 E: info@johnguest.com

johnguest.com



John Guest USA Inc.

180 Passaic Avenue, PO Box 11085, Fairfield,
New Jersey, 07004-7085, USA

T: (001) 973 808 5600 E: info@jgusa.com



John Guest S.A.

143 - 147 Avenue Charles Floquet, Parc Gustave Eiffel,
93593 Le Blanc-Mesnil, Cedex, France

T: (00 33) (0)1 48 65 52 29 E: info@johnguest.fr



John Guest GmbH

Ludwig-Erhard-Allee 30, D-33719 Bielefeld, Germany

T: (00 49) (521) 972 560 E: info@johnguest.de



John Guest Czech s.r.o.

Vrbenská 2290, CZ-37001 České Budějovice,
Czech Republic

T: (00 420) (387) 002 040 E: info@johnguest.cz



John Guest Polska Sp. z o.o.

Ul. Starołęcka 7, PL 61-361 Poznan, Poland

T: (00 48) (61) 87 80 408 E: info@johnguest.pl



John Guest s.r.l.

Via Vincenzo Lancia 13, 10038 Casabianca -
Verolengo (Torino), Italy

T: (00 39) (011) 957 5880 E: info-italia@johnguest.com



John Guest s.l.

C/ de La Electronica No. 7, Poligono Industrial La Ferreria,
Montcada i Reixac, 08110 Barcelona, Spain

T: (0034) (93) 575 0027 E: jgspain@johnguest.com



John Guest Korea Limited

A-dong 112 & 212 ho, Togisanup2cha, Jisiksanup Center,
61 Ganam-ro, Seo-gu, Incheon, South Korea

T: (00 82) (32) 584 3370 E: info@johnguest.co.kr



John Guest Pacific Limited

81 Apollo Drive, Roseland 0632, Auckland, New Zealand

T: (00 64) (9) 8281353 E: info@johnguest.co.nz



John Guest Pacific Limited (Australia)

Unit 6, 33 Nyrang Street, Lidcombe, Sydney,
N.S.W. 2141, Australia

T: (00 61) (2) 9737 9088 E: info@johnguest.com.au

EST. 1961 
AS BRITISH AS THE DAY IT WAS BORN

Product Selection and Installation

John Guest fittings and related products are specifically designed and manufactured by John Guest to the Technical Specifications set out in the John Guest Product Catalogues. All John Guest fittings and related products should be selected, installed, used and maintained in accordance with these Technical Specifications. It is the customer's / user's responsibility to ensure that John Guest fittings and related products are suitable for their intended applications, and are properly installed and maintained and are used in accordance with the Technical Specifications. It is also the customer's / user's responsibility to provide it's customers with any relevant technical information about John Guest products it supplies them.

The company has a policy of continuous research and development and reserves the right to amend without notice the specification and design of all products illustrated in this catalogue. John Guest reserve the right to change the colour and shape of products. Photographs are for illustration purposes only.

Subject to our Terms and Conditions of Sale available on request.

 John Guest® and Speedfit® are registered trademarks of John Guest International Limited © Copyright 2016.

Z2105/87/0416